



# METAL-PI s.n.c.

ACCESSORI PER AGRICOLTURA  
DISERBO · IRRORAZIONE · IRRIGAZIONE  
*Agricultural equipment · Spraying and irrigation*





**LANCE BASSA PRESSIONE E GETTI**

**1**

*Low pressure spray guns and nozzles*

pag. 5



**RACCORDERIA IN OTTONE**

**2**

*Brass hoses*

pag. 17

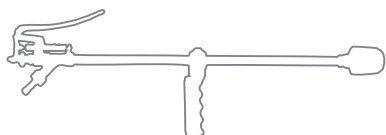

**LANCE LEVA E MANOPOLA 15-40 ATM**

**3**

*Trigger and handle spray guns 15-40 atm*

pag. 23

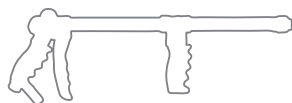

**LANCE ALTA PRESSIONE 40-250 ATM**

**4**

*Long range and washing spray guns*

pag. 39



**NEBULIZZATORI, GETTI E  
E BARRE DISERBANTI**

**5**

*Nozzles and spraying boom*

pag. 45



**GETTI DISERBO  
PER ATOMIZZATORI**

**6**

*Spray Nozzles for air blast sprayers*

pag. 53



**RACCORDERIA IN OTTONE  
E GIUNTI GIREVOLI**

**7**

*Brass hoses and connections*

pag. 57



**IRRIGATORI**

**8**

*Sprinklers*

pag. 59





La ditta Metal-PI s.n.c. nasce dall'unione di due dei fratelli Pasotti nel 1986, quando scelgono di staccarsi dalla ditta del padre, decidendo di capitalizzare la tradizione familiare nell'esperienza di lavorazione di ottonami come terzisti e portarla a un nuovo livello. Negli anni a seguire i fratelli Pasotti ampliano la loro esperienza entrando nel mercato con la creazione di una propria gamma di prodotti del settore agricolo, specializzandosi in articoli per il diserbo, l'irrorazione e zootecnia.

Da subito molto attenta alle tendenze di mercato, ha ideato e realizzato una serie di prodotti che, pur ricalcando gli schemi tradizionali, segna un decisivo progresso di qualità grazie all'accurata scelta dei materiali, un attento collaudo ed una precisione di funzionamento, fattore incisivo che porta la Metal-PI ad essere riconosciuta nel mercato nazionale e ben presto ad esportare i suoi prodotti in tutto il mondo. Il marchio Metal-PI si afferma rapidamente nel ramo agricolo, fino a diventare uno dei leader del settore. Da sempre l'Azienda progetta e costruisce direttamente tutta la gamma dei suoi prodotti, curando con scrupolo artigianale ogni modello realizzato. Inoltre, grazie allo studio tecnico che opera all'interno, offre un servizio di consulenza personalizzato in grado di soddisfare le specifiche richieste dei Clienti più esigenti.

Nell'ottica di accontentare tutta la clientela, nel 1991, i fratelli Pasotti accettano una nuova sfida e allargano la gamma dei loro prodotti con la sezione irrigazione, creando gli irrigatori in alluminio.

Oggi la Metal-PI snc può considerarsi un modello esemplare di piccola impresa a grande presenza internazionale.

*The company Metal-Pi was founded in 1986 when the two brothers Ernesto and Maurizio Pasotti decided to divide from their father's firm and to capitalize their experience in brass manufacturing, bringing it to a higher level.*

*As years went by, the new Pasotti firm further increased their expertise by entering the market with a brand new range of products of their own conception for the agricultural industry, majoring in weeding, spraying and zootechnics.*

*With an immediate and strong care towards the market trends, the new Firm has conceived and created a range of products that, even following the traditional schemes, raises the bar in quality, thanks to the accurate selection of materials, the careful quality check process and the precision in operation. These factors allow Metal-Pi to be well known on the national market and soon to export its products all over the world.*

*The Metal-Pi brand quickly establishes itself in the agricultural field and becomes one of the leaders in the matter. Since the beginning, the Company has planned and developed all the ranges of its products, taking good care of every piece. Besides, it offers a consulting service able to satisfy any specific need of the most demanding customers.*

*With the aim of fulfilling all their customers' needs, in 1991 the two brothers accepted a new challenge and widened the range of their products with the branch of irrigation, creating the aluminum sprinklers.*

*Today Metal-Pi can be considered an exemplary model of a small business with a large international presence.*

Associati dal 2008



Federazione Nazionale Costruttori  
Macchine per l'Agricoltura



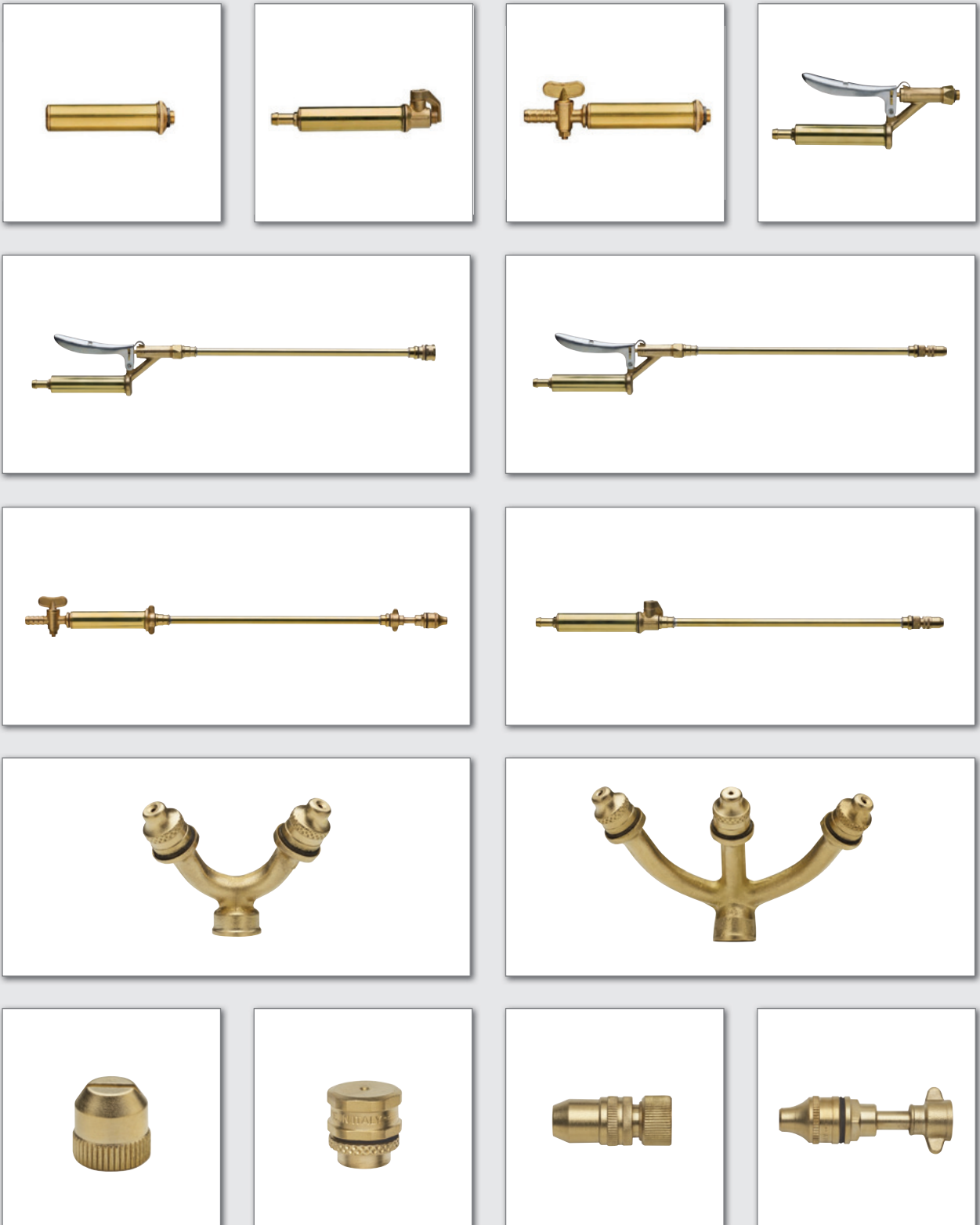



**Confezioni minime 10 pz.**  
Minimum quantity orders 10 pcs.

**Lancia con rubinetto leva**  
*Spray with lever bibcock*

**CODICE** • Code      **MISURA** • Size

<b>78.F.77000</b>	50 cm
<b>78.F.77060</b>	60 cm
<b>78.F.77075</b>	75 cm



**Confezioni minime 10 pz.**  
Minimum quantity orders 10 pcs.

**Lancia con rubinetto leva  
c/ getto a rosa fisso**  
*Spray with lever bibcock and fixed sprayer*

**CODICE** • Code      **MISURA** • Size

<b>78.F.77001</b>	50 cm
-------------------	-------



**Confezioni minime 10 pz.**  
Minimum quantity orders 10 pcs.

**Lancia con rubinetto leva  
c/ getto mini spray**  
*Spray with lever bibcock and mini spray nozzle*

**CODICE** • Code      **MISURA** • Size

<b>78.F.77002</b>	50 cm
-------------------	-------



**Confezioni minime 10 pz.**  
Minimum quantity orders 10 pcs.

**Lancia con rubinetto leva  
c/ getto economico pluvio**  
*Spray with lever bibcock and economical pluvio sprayer*

**CODICE** • Code      **MISURA** • Size

<b>78.F.77003</b>	50 cm
-------------------	-------



### Lancia con rubinetto leva c/ getto regolabile pesante

*Spray with lever bibcock  
and adjustable heavy type sprayer*

**Confezioni minime 10 pz.**  
*Minimum quantity orders 10 pcs.*

**CODICE** • Code      **MISURA** • Size

**78.F.77004**      50 cm



### Lancia bassa pressione con filtro

*Low pressure spray nozzle with filter*

**Confezioni minime 10 pz.**  
*Minimum quantity orders 10 pcs.*

**CODICE** • Code

**78.F.50000**



### Lancia bassa pressione con getto a rosa fisso

*Low pressure spray nozzle with fixed sprayer*

**Confezioni minime 10 pz.**  
*Minimum quantity orders 10 pcs.*

**CODICE** • Code

**78.F.50001**



### Lancia bassa pressione con getto mini spray

*Low pressure spray nozzle with mini spray nozzle*

**Confezioni minime 10 pz.**  
*Minimum quantity orders 10 pcs.*

**CODICE** • Code

**78.F.50002**



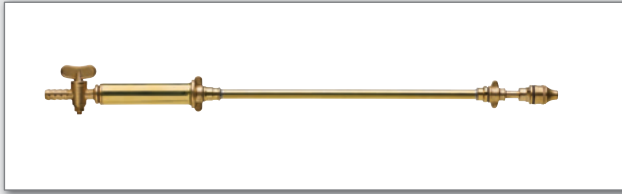

**Confezioni minime 10 pz.**  
*Minimum quantity orders 10 pcs.*

### Lancia bassa pressione con getto economico pluvio

*Low pressure spray nozzle with economical pluvio sprayer*

**CODICE** • Code

**78.F.50003**



**Confezioni minime 10 pz.**  
*Minimum quantity orders 10 pcs.*

### Lancia bassa pressione con getto pesante regolabile

*Low pressure spray nozzle  
with adjustable heavy type sprayer*

**CODICE** • Code

**78.F.50004**



**Confezioni minime 10 pz.**  
*Minimum quantity orders 10 pcs.*

### Lancia bassa pressione a sfera

*Low pressure nozzle with ball-cock*

**CODICE** • Code

**78.F.65000**

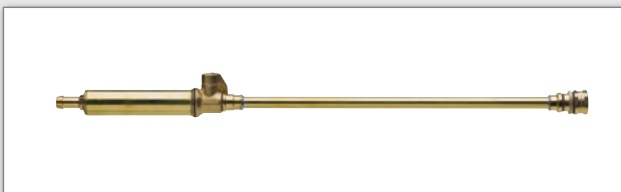

**Confezioni minime 10 pz.**  
*Minimum quantity orders 10 pcs.*

### Lancia bassa pressione a sfera c/ getto rosa fisso

*Low pressure nozzle with ball-cock fixed sprayer*

**CODICE** • Code

**78.F.65001**



**Confezioni minime 10 pz.**  
Minimum quantity orders 10 pcs.

### Lancia bassa pressione a sfera c/ getto mini spray

*Low pressure nozzle with ball-cock mini spray nozzle*

**CODICE** • Code

**78.F.65002**

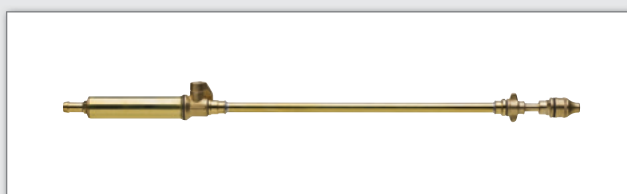

**Confezioni minime 10 pz.**  
Minimum quantity orders 10 pcs.

### Lancia bassa pressione a sfera c/ getto economico pluvio

*Low pressure nozzle  
with ball-cock economical pluvio sprayer*

**CODICE** • Code

**78.F.65003**

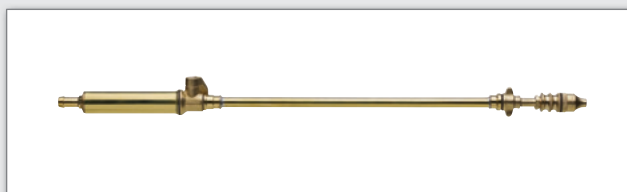

**Confezioni minime 10 pz.**  
Minimum quantity orders 10 pcs.

### Lancia bassa pressione a sfera c/ getto pesante regolabile

*Low pressure nozzle with ball-cock adjustable sprayer  
heavy type*

**CODICE** • Code

**78.F.65004**



**Confezioni minime 20 pz.**  
Minimum quantity orders 20 pcs.

### Rubinetto fisso senza "peronospera"

*Fixed bibcock without peronospera*

**CODICE** - Code

**78.F.00000**



**Confezioni minime 20 pz.**  
Minimum quantity orders 20 pcs.

### Rubinetto fisso

*Fixed bibcock*

**CODICE** - Code

**78.F.00001**



**Confezioni minime 20 pz.**  
Minimum quantity orders 20 pcs.

### Rubinetto sfera lance bassa pressione

*Ball bibcock for low pressure nozzle*

**CODICE** - Code

**78.F.00002**



**Confezioni minime 20 pz.**  
Minimum quantity orders 20 pcs.

### Rubinetto a leva

*Lever bibcock*

**CODICE** - Code

**78.F.00003**

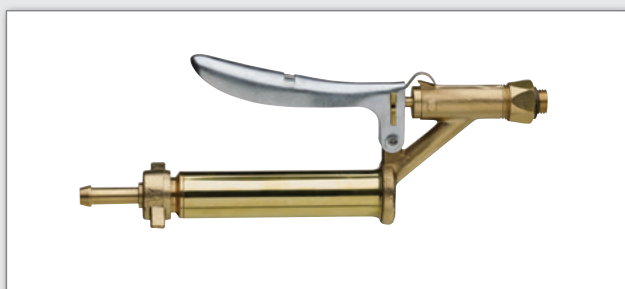

### Rubinetto a leva c/portagomma

Lever bibcock with heavy hose shank

Confezioni minime 20 pz.  
Minimum quantity orders 20 pcs.

CODICE • Code

<b>78.F.00009</b>	rubinetto a leva att. 3/8" • Lever bibcock 3/8"
<b>78.F.00008</b>	rubinetto a leva att. 1/2" • Lever bibcock 1/2"
<b>78.F.00007</b>	rubinetto a leva att. 1/2" c/portagomma ø 8 • Lever bibcock 1/2" with heavy hose shank ø 8
<b>78.F.00006</b>	rubinetto a leva att. 1/2" c/portagomma ø 10 • Lever bibcock 1/2" with heavy hose shank ø 10
<b>78.F.00005</b>	rubinetto a leva att. 3/8" c/portagomma ø 8 • Lever bibcock 3/8" with heavy hose shank ø 8
<b>78.F.00004</b>	rubinetto a leva att. 3/8" c/portagomma ø 10 • Lever bibcock 3/8" with heavy hose shank ø 10

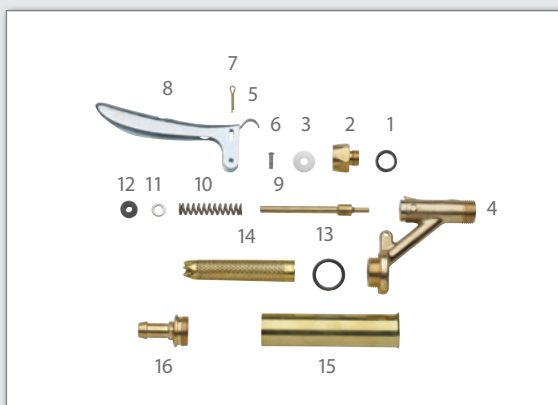

### Esploso rubinetto a leva

Low pressure lever bibcock exploded

CODICE • Code

<b>1</b>	<b>04.K.00000</b>	Guarnizione 15,5x11x2,4 • Rubber seal
<b>2</b>	<b>53.T.03812</b>	Riduzione 3/8"x12x19 filetti • Reduction
<b>3</b>	<b>04.P.15052</b>	Guarnizione PTFE 15x5x2 • Rubber seal PTFE
<b>4</b>	<b>00.T.00009</b>	Corpo rubinetto leva • Bibcock
<b>5</b>	<b>07.A.00007</b>	Molla balestrina • Handle spring
<b>6</b>	<b>20.A.00000</b>	Ribattino • Spike
<b>7</b>	<b>20.T.00001</b>	Coppiglia ottone • Brass stopper
<b>8</b>	<b>09.A.00001</b>	Maniglia acciaio • Stainless steel handle
<b>9</b>	<b>54.T.00000</b>	Spillo • Stem piston
<b>10</b>	<b>07.A.00006</b>	Molla • Lever inner spring
<b>11</b>	<b>06.T.10001</b>	Rondella 10x1 • Brass ring
<b>12</b>	<b>04.K.00001</b>	Guarnizione 11,5x4,5x4 • Seal
<b>13</b>	<b>01.K.00014</b>	Or 14 • Seal
<b>14</b>	<b>13.T.00000</b>	Filtro • Filter
<b>15</b>	<b>44.T.00000</b>	Custodia portafiltro • Brass filter cartridge
<b>16</b>	<b>28.T.17010</b>	Portagomma ø 10 • Hose

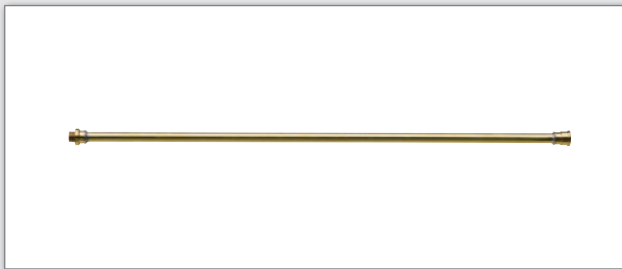

**Confezioni minime 50 pz.**  
Minimum quantity orders 50 pcs.

### Prolunga diritta ottone

*Brass extension*

**CODICE** • Code      **MISURA** • Size

**68.F.TD030**      30 cm

**68.F.TD050**      50 cm

**68.F.TD060**      60 cm

**68.F.TD075**      75 cm

**68.F.TD100**      100 cm



**Confezioni minime 50 pz.**  
Minimum quantity orders 50 pcs.

### Prolunga diritta acciaio

*Stainless steel extension*

**CODICE** • Code      **MISURA** • Size

**68.F.AD050**      50 cm

**68.F.AD075**      75 cm

**68.F.AD100**      100 cm

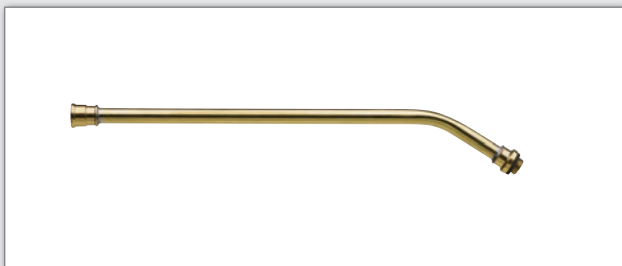

**Confezioni minime 50 pz.**  
Minimum quantity orders 50 pcs.

### Prolunga curva ottone

*Bended brass extension*

**CODICE** • Code      **MISURA** • Size

**68.F.TC030**      30 cm

**68.F.TC050**      50 cm

**68.F.TC075**      75 cm



**Confezioni minime 50 pz.**  
Minimum quantity orders 50 pcs.

### Prolunga curva acciaio

*Bended stainless steel extension*

**CODICE** • Code      **MISURA** • Size

**68.F.AC050**      50 cm

**68.F.AC075**      75 cm

**68.F.AC100**      100 cm

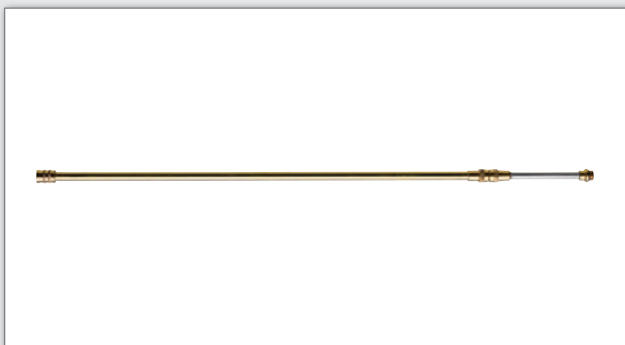

**Confezioni minime 50 pz.**  
Minimum quantity orders 50 pcs.

### Prolunga telescopica diritta

*Straight telescopic extension*

**CODICE** • Code    **MISURA** • Size

**68.F.D5050**    50+50 cm

**68.F.D7575**    75+75 cm

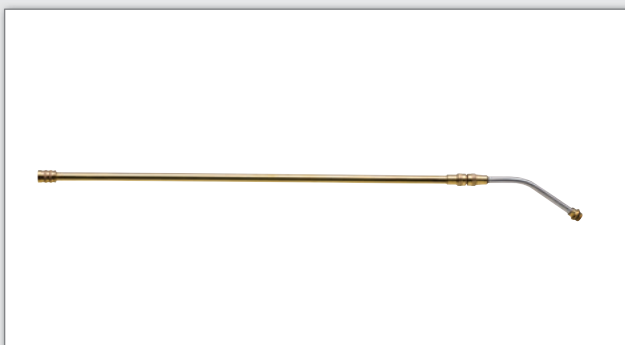

**Confezioni minime 50 pz.**  
Minimum quantity orders 50 pcs.

### Prolunga telescopica curva

*Bended telescopic extension*

**CODICE** • Code    **MISURA** • Size

**68.F.C5050**    50+50 cm

**68.F.C7575**    75+75 cm



### Getto a ventaglio

*Hose sprayer  
for low pressure nozzle*

CODICE • Code

67.F.00000

**Confezioni minime 100 pz.**  
*Minimum quantity orders 50 pcs.*



### Getto rosa fisso

*Fixed nozzle*

CODICE • Code

67.F.00001

**Confezioni minime 100 pz.**  
*Minimum quantity orders 50 pcs.*



### Getto mini spray

*Mini sprayer*

CODICE • Code

67.F.00002

**Confezioni minime 50 pz.**  
*Minimum quantity orders 50 pcs.*



### Getto economico pluvio

*Economical pluvio sprayer*

CODICE • Code

67.F.00003

**Confezioni minime 50 pz.**  
*Minimum quantity orders 50 pcs.*

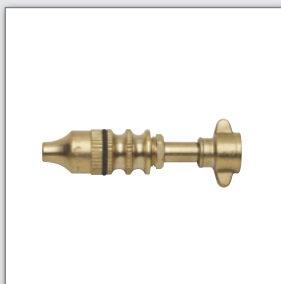

### Getto pesante regolabile

*Adjustable heavy  
type sprayer*

CODICE • Code

67.F.00004

**Confezioni minime 50 pz.**  
*Minimum quantity orders 50 pcs.*



**Getto biforcuto**  
2-fork sprayer

CODICE - Code

67.F.2B000

Confezioni minime 10 pz.  
Minimum quantity orders 10 pcs.



**Getto triforcuto**  
3-fork sprayer

CODICE - Code

67.F.3B000

€

Confezioni minime 10 pz.  
Minimum quantity orders 100 pcs.



**Getto quadriforcuto**  
4-fork sprayer

CODICE - Code

MISURA - Size

67.F.4B000

50 cm

67.F.4B100

100 cm

67.F.4B120

120 cm

Confezioni minime 10 pz.  
Minimum quantity orders 10 pcs.



**Elichetta**  
Jet conveyor

CODICE - Code

11.T.00000

Confezioni minime 10 pz.  
Minimum quantity orders 10 pcs.

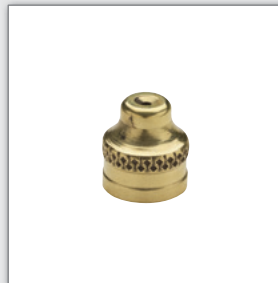

**Cappellotto ø 15x19**  
Cap ø 15x19

CODICE - Code

25.T.15019

Confezioni minime 10 pz.  
Minimum quantity orders 10 pcs.



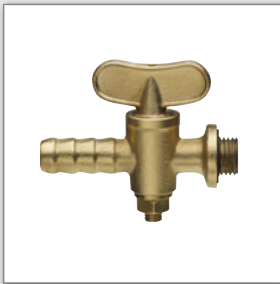

**Rubinetto peronospera**  
*Peron sphere valve*

CODICE • Code

79.F.T1219

Confezioni minime 50 pz.  
*Minimum quantity orders 50 pcs.*

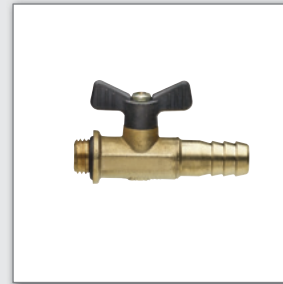

**Rubinetto peronospera a sfera**  
*Peron sphere ball valve*

CODICE • Code

65.F.T1219

Confezioni minime 50 pz.  
*Minimum quantity orders 50 pcs.*



**Campana per diserbo localizzato con getto a ventaglio**

*Bell for localized weed removal with fan nozzle*

CODICE • Code

15.F.V5310

Confezioni minime 5 pz.  
*Minimum quantity orders 5 pcs.*



**Campana per diserbo localizzato con ugello a rosa**

*Bell for localized weed removal with cone nozzle*

CODICE • Code

15.F.R5310

Confezioni minime 5 pz.  
*Minimum quantity orders 5 pcs.*



**Curva portagetto**  
**ø12x19**

*Bended M/F connector*  
*ø12x19*

CODICE • Code

27.F.T1219

Confezioni minime 100 pz.  
*Minimum quantity orders 100 pcs.*

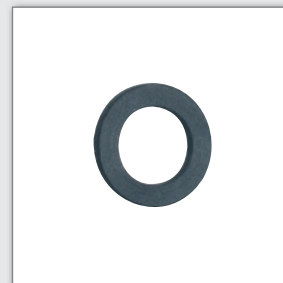

**Guarnizione**  
**cm. 15,5x11x2,4**

*Seal cm. 15,5x11x2,4*

CODICE • Code

04.K.00000

Confezioni minime 100 pz.  
*Minimum quantity orders 100 pcs.*



**Portagomma**  
**2 pezzi c/ girello 3/8"**

*Double hose shank with fly nut 3/8"*

CODICE • Code      MISURA • Size

28.F.38008      ø 8

28.F.38010      ø 10

Confezioni minime 100 pz.  
*Minimum quantity orders 100 pcs.*

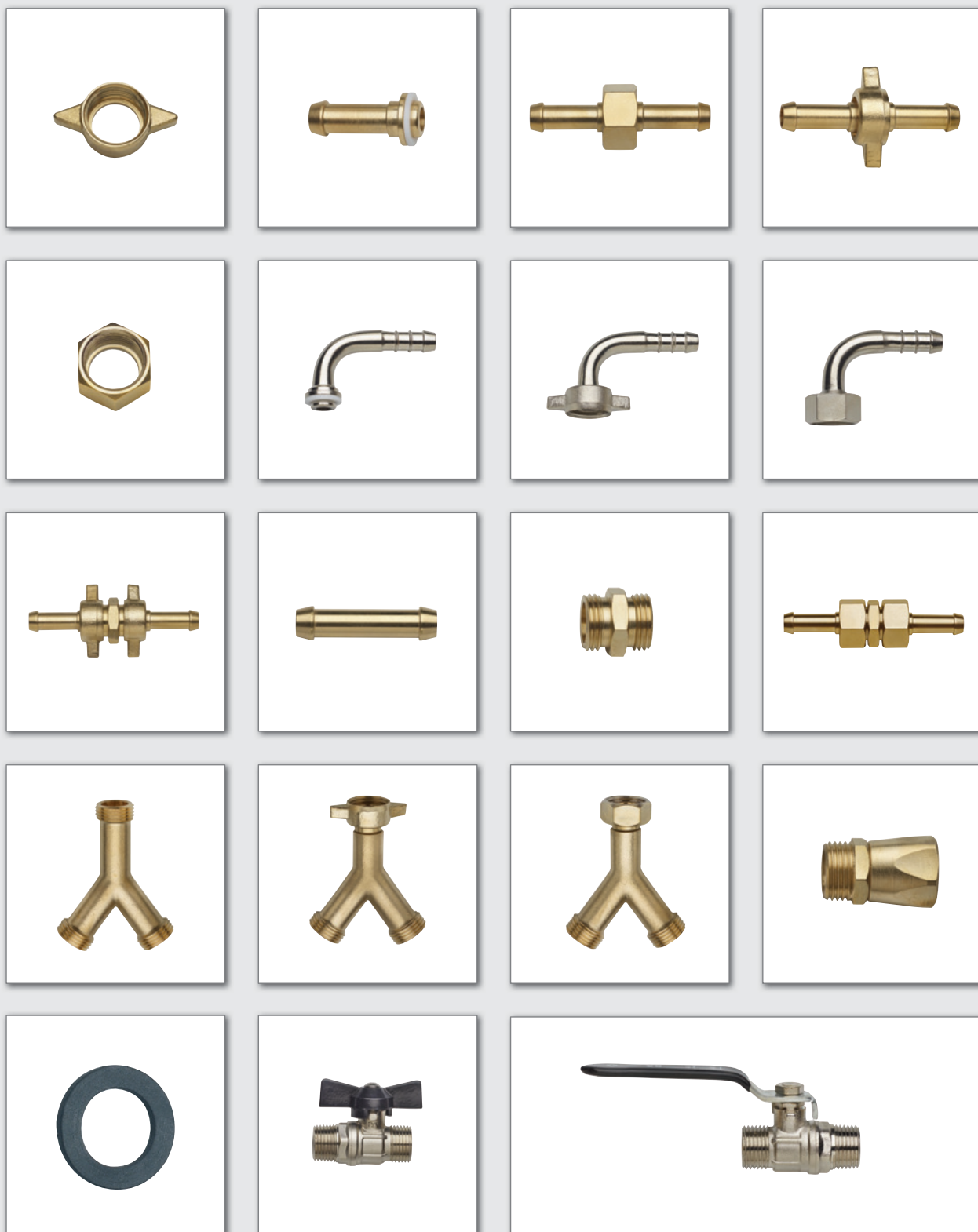



### Portagomma c/ guarnizione

Brass hose shank with seal

Confezioni minime 100 pz.  
Minimum quantity orders 100 pcs.

CODICE - Code      MISURA - Size

28.F.00408	ø 8
28.F.00410	ø 10
28.F.00413	ø 13

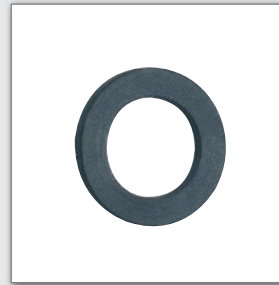

### Guarnizione PTFE

Hose seal PTFE

Confezioni minime 100 pz.  
Minimum quantity orders 100 pcs.

CODICE - Code      MISURA - Size

04.P.01802	cm. 18x12,5x1,8
------------	-----------------



### Girello

Fly nut

Confezioni minime 100 pz.  
Minimum quantity orders 100 pcs.

CODICE - Code      MISURA - Size

30.T.00000	1/2"
30.T.00001	3/8"
30.T.00002	3/4"



### Portagomma dritto filettato da 1/2"

Threaded hose 1/2"

Confezioni minime 100 pz.  
Minimum quantity orders 100 pcs.

CODICE - Code      MISURA - Size

28.T.12008	ø 8x1/2"
28.T.12010	ø 10x1/2"
28.T.12013	ø 13x1/2"



### Portagomma 2 pezzi c/ girello

Combined 2 pieces hose with fly nut

Confezioni minime 100 pz.  
Minimum quantity orders 100 pcs.

CODICE - Code      MISURA - Size

28.F.30048	ø 8x1/2"
28.F.30410	ø 10x1/2"
28.F.30413	ø 13x1/2"

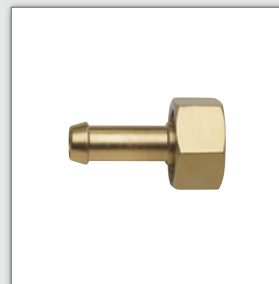

### Portagomma 2 pezzi c/ dado

Combined 2 pieces hose with hexagonal nut

Confezioni minime 100 pz.  
Minimum quantity orders 100 pcs.

CODICE - Code      MISURA - Size

28.F.10048	ø 8x1/2"
28.F.10410	ø 10x1/2"
28.F.10413	ø 13x1/2"



### Portagomma 3 pezzi c/ girello

Combined 3 pieces hose  
with nut

Confezioni minime 100 pz.  
Minimum quantity orders 100 pcs.

CODICE • Code MISURA • Size

28.F.30008 ø 8x1/2"

28.F.30010 ø 10x1/2"

28.F.30013 ø 13x1/2"

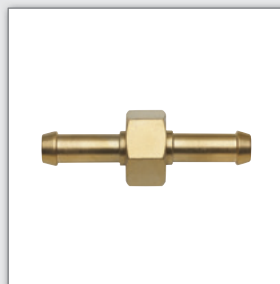

### Portagomma 3 pezzi c/ dado

Combined 3 pieces hose  
with hexagonal nut

Confezioni minime 100 pz.  
Minimum quantity orders 100 pcs.

CODICE • Code MISURA • Size

28.F.10008 ø 8x1/2"

28.F.10010 ø 10x1/2"

28.F.10013 ø 13x1/2"

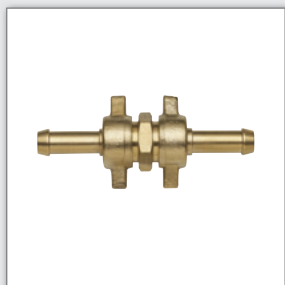

### Portagomma 5 pezzi c/ girello

Combined 5 pieces hose  
with nut

Confezioni minime 100 pz.  
Minimum quantity orders 100 pcs.

CODICE • Code MISURA • Size

28.F.12G08 ø 8x1/2"

28.F.12G10 ø 10x1/2"



### Portagomma 5 pezzi c/ dado

Combined 5 pieces hose  
with hexagonal nut

Confezioni minime 100 pz.  
Minimum quantity orders 100 pcs.

CODICE • Code MISURA • Size

28.F.12D08 ø 8x1/2"

28.F.12D10 ø 10x1/2"



### Giunzione

Connection

Confezioni minime 100 pz.  
Minimum quantity orders 100 pcs.

CODICE • Code MISURA • Size

64.T.00008 ø 8

64.T.00010 ø 10



### Riduzione MM

Reduction MM

Confezioni minime 100 pz.  
Minimum quantity orders 100 pcs.

CODICE • Code MISURA • Size

53.T.01214 1/2"x1/4"

53.T.01238 1/2"x3/8"

53.T.01212 1/2"x1/2"



**Curva 2 pezzi con girello**

*Bended brass 2 pieces hose shank with nut*

**Confezioni minime 100 pz.**  
*Minimum quantity orders 100 pcs.*

**CODICE** - Code    **MISURA** - Size

<b>27.F.30048</b>	ø 8x1/2"
<b>27.F.30495</b>	ø 9,5x1/2"
<b>27.F.30410</b>	ø 10x1/2"
<b>27.F.30413</b>	ø 13x1/2"

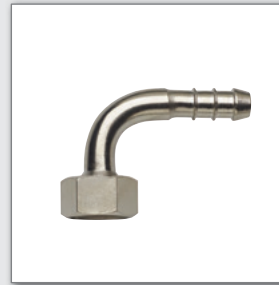

**Curva 2 pezzi c/ dado**

*Bended brass hose shank with hexagonal nut*

**Confezioni minime 100 pz.**  
*Minimum quantity orders 100 pcs.*

**CODICE** - Code    **MISURA** - Size

<b>27.F.10048</b>	ø 8x1/2"
<b>27.F.10495</b>	ø 9,5x1/2"
<b>27.F.10410</b>	ø 10x1/2"
<b>27.F.10413</b>	ø 13x1/2"

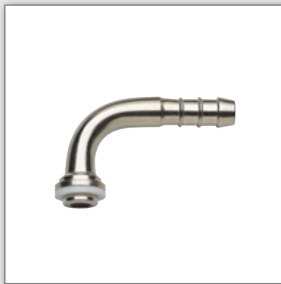

**Curva c/ guarnizione**

*Bended brass hose shank with seal*

**Confezioni minime 100 pz.**  
*Minimum quantity orders 100 pcs.*

**CODICE** - Code    **MISURA** - Size

<b>27.F.00408</b>	ø 8
<b>27.F.00495</b>	ø 9,5
<b>27.F.00410</b>	ø 10
<b>27.F.00413</b>	ø 13



**Rubinetto a sfera**

*Ball valve*

**Confezioni minime 25 pz.**  
*Minimum quantity orders 25 pcs.*

**CODICE** - Code    **MISURA** - Size

<b>65.F.A1212</b>	1/2"x1/2"
<b>65.F.A3812</b>	3/8"x1/2"



**Rubinetto a sfera con maniglia nylon corta**

*Ball bibcock with short nylon handle*

**Confezioni minime 25 pz.**  
*Minimum quantity orders 25 pcs.*

**CODICE** - Code    **MISURA** - Size

<b>65.F.N3812</b>	3/8"x1/2"
<b>65.F.N1212</b>	1/2"x1/2"

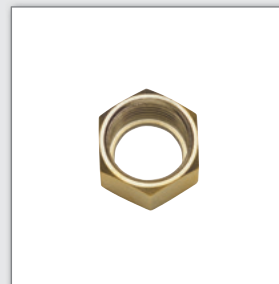

**Dado**

*Hexagonal nut*

**Confezioni minime 100 pz.**  
*Minimum quantity orders 100 pcs.*

**CODICE** - Code    **MISURA** - Size

<b>10.T.00003</b>	CH. 24x1/2"
<b>10.T.00002</b>	CH. 30x3/4"
<b>10.T.00008</b>	CH. 24x1/2" ALTO



**Raccordo a 3 vie 1/2"**  
*3 Ways connection 1/2"*

**Confezioni minime 25 pz.**  
*Minimum quantity orders 25 pcs.*

**CODICE** • Code    **MISURA** • Size

**57.T.12012**    1/2"



**Raccordo a 3 vie 1/2"**  
**con girello**  
*3 Ways connection 1/2"*  
*with nut*

**Confezioni minime 25 pz.**  
*Minimum quantity orders 25 pcs.*

**CODICE** • Code    **MISURA** • Size

**57.F.30012**    1/2"



**Raccordo a 3 vie 1/2"**  
**c/ dado**  
*3 Ways connector 1/2"*  
*with hexagonal nut*

**Confezioni minime 25 pz.**  
*Minimum quantity orders 25 pcs.*

**CODICE** • Code    **MISURA** • Size

**57.F.10012**    1/2"



**Raccordo girevole**  
*Swivel connection*

**Confezioni minime 100 pz.**  
*Minimum quantity orders 100 pcs.*

**CODICE** • Code    **MISURA** • Size

**28.F.G1212**    1/2" m x 1/2" f





LANCE LEVA E  
MANOPOLA 15÷40 ATM  
Trigger and handle  
spray guns 15-40 atm





**Confezioni minime 25 pz.**  
Minimum quantity orders 25 pcs.

### Lancia a leva Trigger spray gun

**CODICE** • Code      **MISURA** • Size

**77.F.03000**      30 cm

**77.F.06000**      60 cm



**Confezioni minime 25 pz.**  
Minimum quantity orders 25 pcs.

### Lancia a leva con testina inox Trigger spray gun with inox head

**CODICE** • Code      **MISURA** • Size

**77.F.03100**      30 cm

**77.F.06100**      60 cm

### Lancia a leva con testina ceramica Trigger spray gun with ceramic head

**CODICE** • Code      **MISURA** • Size

**77.F.03C00**      30 cm

**77.F.06C00**      60 cm



**Confezioni minime 25 pz.**  
Minimum quantity orders 25 pcs.

### Lancia a leva c/ portagomma Trigger spray gun with hose shank

**CODICE** • Code      **MISURA** • Size

**77.F.03008**      30 cm c/ portagomma ø 8

**77.F.06008**      60 cm c/ portagomma ø 8

**77.F.03010**      30 cm c/ portagomma ø 10

**77.F.06010**      60 cm c/ portagomma ø 10



Confezioni minime 25 pz.  
Minimum quantity orders 25 pcs.

**Lancia a leva c/ testina inox c/ portagomma**  
Trigger spray gun with inox head and hose shank

CODICE • Code	MISURA • Size
77.F.03I08	30 cm c/ portagomma ø 8
77.F.06I08	60 cm c/ portagomma ø 8
77.F.03I10	30 cm c/ portagomma ø 10
77.F.06I10	60 cm c/ portagomma ø 10

**Lancia a leva c/ testina ceramica c/ portagomma**  
Trigger spray gun with ceramic head and hose shank

CODICE • Code	MISURA • Size
77.F.03C08	30 cm c/ portagomma ø 8
77.F.06C08	60 cm c/ portagomma ø 8
77.F.03C10	30 cm c/ portagomma ø 10
77.F.06C10	60 cm c/ portagomma ø 10

LANCE LEVA E  
MANOPOLA 15÷40 ATM  
Trigger and handle  
spray guns 15-40 atm



Confezioni minime 5 pz.  
Minimum quantity orders 5 pcs.

**Lancia a leva c/ impugnatura intermedia**  
Trigger spray gun with intermediate handle

CODICE • Code	MISURA • Size
77.F.08000	80 cm
77.F.10000	100 cm
77.F.15000	150 cm



Confezioni minime 5 pz.  
Minimum quantity orders 5 pcs.

**Lancia a leva c/ testina inox ed impugnatura intermedia**  
Trigger spray gun with inox head and intermediate handle

CODICE • Code	MISURA • Size
77.F.08I00	80 cm
77.F.10I00	100 cm
77.F.15I00	150 cm

**Lancia a leva c/ testina ceramica ed impugnatura intermedia**  
Trigger spray gun with ceramic head and intermediate handle

CODICE • Code	MISURA • Size
77.F.08C00	80 cm
77.F.10C00	100 cm
77.F.15C00	150 cm



**Confezioni minime 5 pz.**  
Minimum quantity orders 5 pcs.

### Lancia a leva c/ testina inox c/ portagomma ed impugnatura intermedia

Trigger spray gun with inox head, hose shank and intermediate handle

**CODICE** - Code      **MISURA** - Size

<b>77.F.10I08</b>	100 cm c/ portagomma ø 8
<b>77.F.15I08</b>	150 cm c/ portagomma ø 8
<b>77.F.10I10</b>	100 cm c/ portagomma ø 10
<b>77.F.15I10</b>	150 cm c/ portagomma ø 10

### Lancia a leva c/ testina ceramica c/ portagomma ed impugnatura intermedia

Trigger spray gun with ceramic head, hose shank and intermediate handle

**CODICE** - Code      **MISURA** - Size

<b>77.F.10C08</b>	100 cm c/ portagomma ø 8
<b>77.F.15C08</b>	150 cm c/ portagomma ø 8
<b>77.F.10C10</b>	100 cm c/ portagomma ø 10
<b>77.F.15C10</b>	150 cm c/ portagomma ø 10



**Confezioni minime 5 pz.**  
Minimum quantity orders 5 pcs.

### Lancia a leva c/ portagomma ed impugnatura intermedia

Trigger spray gun with hose shank and intermediate handle

**CODICE** - Code      **MISURA** - Size

<b>77.F.10008</b>	100 cm c/ portagomma ø 8
<b>77.F.15008</b>	150 cm c/ portagomma ø 8
<b>77.F.10010</b>	100 cm c/ portagomma ø 10
<b>77.F.15010</b>	150 cm c/ portagomma ø 10



### Maniglia intermedia

Intermediate handle

**CODICE** - Code

**09.F.00016**

**Confezioni minime 10 pz.**  
Minimum quantity orders 10 pcs.

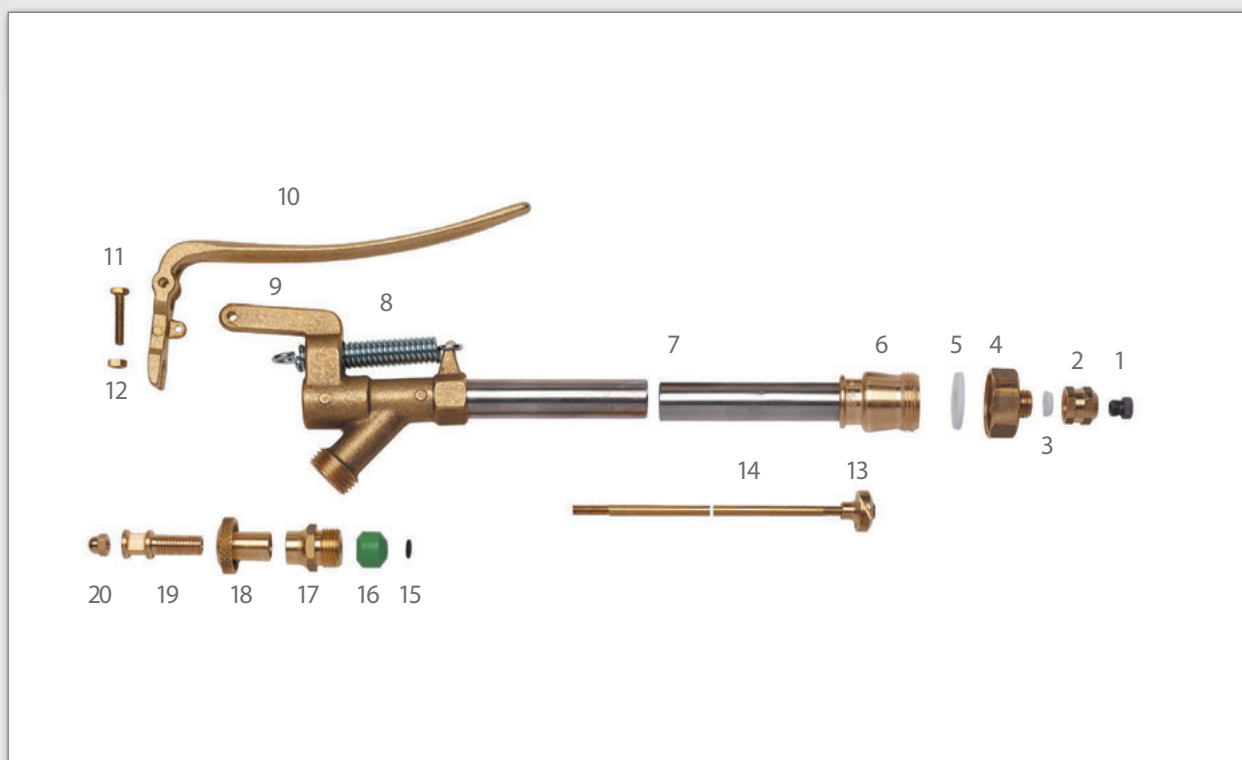

## Esploso lancia a leva

Trigger spray gun exploded

### CODICE • Code

1	<b>03.I.00015</b>	Ugello inox • <i>Inox spray</i>
2	<b>24.T.00002</b>	Portaugello • <i>Spray support</i>
3	<b>04.P.10653</b>	Guarnizione tenuta ugello PTFE • <i>Rubber seal or PTFE</i>
4	<b>29.T.12019</b>	Calotta • <i>Hose</i>
5	<b>04.P.09233</b>	Guarnizione tenuta calotta • <i>Hose seal</i>
6	<b>59.T.25032</b>	Camera di convogliamento • <i>Conveyment chamber</i>
7	<b>02.A.16047</b>	Tubo acciaio • <i>Steel pipe</i>
8	<b>07.A.00005</b>	Molla • <i>Spring</i>
9	<b>00.T.00003</b>	Corpo • <i>Body</i>
10	<b>09.T.00001</b>	Maniglia ottone • <i>Brass handle</i>
11	<b>08.T.04020</b>	Vite M4 ottone • <i>Brass screw M4</i>
12	<b>10.T.00000</b>	Dado M4 ottone • <i>Brass hexagonal nut M4</i>
13	<b>14.T.19015</b>	Deviatore • <i>Switch</i>
14	<b>45.T.50042</b>	Asta • <i>Connection road</i>
15	<b>01.K.00003</b>	Or 3 • <i>Seal 3</i>
16	<b>04.P.00000</b>	Ogiva • <i>Green seal</i>
17	<b>50.T.00001</b>	Premistoppa • <i>Gland</i>
18	<b>46.T.00000</b>	Regolatore • <i>Pressure regulator</i>
19	<b>47.T.00000</b>	Distanziatore • <i>Spacer</i>
20	<b>51.T.00000</b>	Borchia M5 • <i>Stud m5</i>



**Confezioni minime 25 pz.**  
Minimum quantity orders 25 pcs.

### Lancia manopola

Handle spray gun

**CODICE** • Code      **MISURA** • Size

**66.F.03000**      30 cm

**66.F.06000**      60 cm



**Confezioni minime 25 pz.**  
Minimum quantity orders 25 pcs.

### Lancia manopola c/ testina inox

Handle spray gun with inox head

**CODICE** • Code      **MISURA** • Size

**66.F.03100**      30 cm

**66.F.06100**      60 cm

### Lancia manopola c/ testina ceramica

Handle spray gun with ceramic head

**CODICE** • Code      **MISURA** • Size

**66.F.03C00**      30 cm

**66.F.06C00**      60 cm



**Confezioni minime 25 pz.**  
Minimum quantity orders 25 pcs.

### Lancia manopola c/ portagomma

Handle spray gun with hose shank

**CODICE** • Code      **MISURA** • Size

**66.F.03008**      30 cm c/ portagomma ø 8

**66.F.06008**      60 cm c/ portagomma ø 8

**66.F.03010**      30 cm c/ portagomma ø 10

**66.F.06010**      60 cm c/ portagomma ø 10



Confezioni minime 25 pz.  
Minimum quantity orders 25 pcs.

### Lancia manopola c/testina inox c/ portagomma

Handle spray gun with inox head and hose shank

CODICE • Code	MISURA • Size
66.F.03I08	30 cm c/ portagomma ø 8
66.F.06I08	60 cm c/ portagomma ø 8
66.F.03I10	30 cm c/ portagomma ø 10
66.F.06I10	60 cm c/ portagomma ø 10

### Lancia manopola c/testina ceramica c/ portagomma

Handle spray gun with ceramic head and hose shank

CODICE • Code	MISURA • Size
66.F.03C08	30 cm c/ portagomma ø 8
66.F.06C08	60 cm c/ portagomma ø 8
66.F.03C10	30 cm c/ portagomma ø 10
66.F.06C10	60 cm c/ portagomma ø 10



Confezioni minime 5 pz.  
Minimum quantity orders 5 pcs.

### Lancia manopola ed impugnatura intermedia

Handle spray gun and intermediate handle

CODICE • Code	MISURA • Size
66.F.08000	80 cm
66.F.10000	100 cm
66.F.15000	150 cm

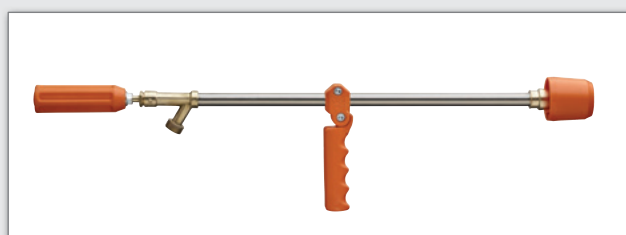

Confezioni minime 5 pz.  
Minimum quantity orders 5 pcs.

### Lancia manopola c/ testina inox ed impugnatura intermedia

Handle spray gun with inox head and intermediate handle

CODICE • Code	MISURA • Size
66.F.08I00	80 cm
66.F.10I00	100 cm
66.F.15I00	150 cm

### Lancia a leva c/ testina ceramica ed impugnatura intermedia

Handle spray gun with ceramic head and intermediate handle

CODICE • Code	MISURA • Size
66.F.08C00	80 cm
66.F.10C00	100 cm
66.F.15C00	150 cm

LANCE LEVA E  
MANOPOLA 15÷40 ATM  
Trigger and handle  
spray guns 15-40 atm

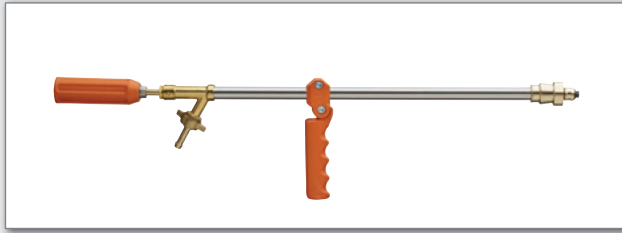

**Confezioni minime 5 pz.**  
Minimum quantity orders 5 pcs.

### Lancia manopola c/ portagomma ed impugnatura intermedia

Handle spray gun with hose shank and intermediate handle

**CODICE** • Code      **MISURA** • Size

<b>66.F.10008</b>	100 cm c/ portagomma ø 8
<b>66.F.15008</b>	150 cm c/ portagomma ø 8
<b>66.F.10010</b>	100 cm c/ portagomma ø 10
<b>66.F.15010</b>	150 cm c/ portagomma ø 10



**Confezioni minime 5 pz.**  
Minimum quantity orders 5 pcs.

### Lancia manopola c/testina inox c/ portagomma ed impugnatura intermedia

Handle spray gun with inox head, hose shank and intermediate handle

**CODICE** • Code      **MISURA** • Size

<b>66.F.10I08</b>	100 cm c/ portagomma ø 8
<b>66.F.15I08</b>	150 cm c/ portagomma ø 8
<b>66.F.10I10</b>	100 cm c/ portagomma ø 10
<b>66.F.15I10</b>	150 cm c/ portagomma ø 10

### Lancia manopola c/testina ceramica c/ portagomma ed impugnatura intermedia

Handle spray gun with ceramic head, hose shank and intermediate handle

**CODICE** • Code      **MISURA** • Size

<b>66.F.10C08</b>	100 cm c/ portagomma ø 8
<b>66.F.15C08</b>	150 cm c/ portagomma ø 8
<b>66.F.10C10</b>	100 cm c/ portagomma ø 10
<b>66.F.15C10</b>	150 cm c/ portagomma ø 10



## Esploso lancia manopola

Handle spray gun exploded

### CODICE • Code

1	<b>03.I.00015</b>	Ugello inox • <i>Inox spray</i>
2	<b>24.T.00002</b>	Portaugello • <i>Spray support</i>
3	<b>04.P.10653</b>	Guarnizione tenuta ugello PTFE • <i>Rubber seal or PTFE</i>
4	<b>29.T.12019</b>	Calotta • <i>Hose</i>
5	<b>04.P.09233</b>	Guarnizione tenuta calotta • <i>Hose seal</i>
6	<b>14.T.19015</b>	Deviatore • <i>Switch</i>
7	<b>45.T.50042</b>	Asta • <i>Connection road</i>
8	<b>08.T.12070</b>	Vite s/ fine • <i>Worm</i>
9	<b>59.T.25032</b>	Camera di convogliamento • <i>Conveyment chamber</i>
10	<b>02.A.16038</b>	Tubo acciaio • <i>Steel pipe</i>
11	<b>00.T.00002</b>	Corpo • <i>Body</i>
12	<b>06.T.14002</b>	Rondella ottone • <i>Brass ring</i>
13	<b>01.K.00006</b>	Or 6 • <i>Seal 6</i>
14	<b>04.P.14088</b>	Ogiva • <i>Green seal</i>
15	<b>50.T.00000</b>	Premistoppa • <i>Gland</i>
16	<b>12.T.00008</b>	Controdado 8 M • <i>Joint 8 M</i>
17	<b>31.P.00000</b>	Manopola • <i>Handle</i>
18	<b>49.P.00000</b>	Tappo • <i>Plug</i>



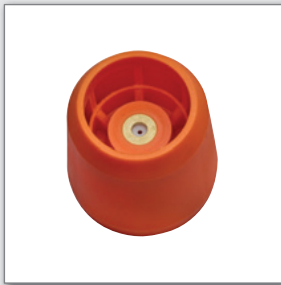

**Testina universale per lance ceramica**  
Ceramic head

**CODICE** • Code    **MISURA** • Size

<b>15.F.00C10</b>	ø 1.0
<b>15.F.00C12</b>	ø 1.2
<b>15.F.00C15</b>	ø 1.5
<b>15.F.00C18</b>	ø 1.8
<b>15.F.00C20</b>	ø 2.0



**Testina universale per lance inox**  
Inox head

**CODICE** • Code    **MISURA** • Size

<b>15.F.00I10</b>	ø 1.0
<b>15.F.00I12</b>	ø 1.2
<b>15.F.00I15</b>	ø 1.5
<b>15.F.00I18</b>	ø 1.8
<b>15.F.00I20</b>	ø 2.0



**Ghiera completa per lance**  
Complete nut

**Confezioni minime 25 pz.**  
Minimum quantity orders 25 pcs.

**CODICE** • Code    **MISURA** • Size

<b>35.F.5P015</b>	ø 1.5
<b>35.F.5P018</b>	ø 1.8

**Espolso ghiera completa per lance**  
Nut for spray gun exploded



**CODICE** • Code

1	<b>03.I.00015</b>	Ugello inox • Inox spray
2	<b>24.T.00002</b>	Portaugello inox • Spray support
3	<b>04.P.10653</b>	Guarnizione tenuta ugello • Rubber seal
4	<b>29.T.12019</b>	Calotta • Hose
5	<b>04.P.09233</b>	Guarnizione tenuta calotta • Hose seal



**Raccordo girevole**  
Swivel connection

**Confezioni minime 100 pz.**  
Minimum quantity orders 100 pcs.

**CODICE** • Code    **MISURA** • Size

<b>28.F.G1212</b>	1/2" m x 1/2" f
-------------------	-----------------

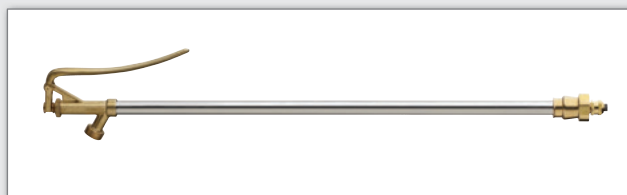

Confezioni minime 25 pz.  
Minimum quantity orders 25 pcs.

**Lancia a leva modello economico**  
*Economical trigger spray gun*

CODICE • Code      MISURA • Size

77.F.E3000      30 cm

77.F.E6000      60 cm



Confezioni minime 25 pz.  
Minimum quantity orders 25 pcs.

**Lancia a leva modello economico con testina inox**  
*Economical trigger spray gun with inox head*

CODICE • Code      MISURA • Size

77.F.E3100      30 cm

77.F.E6100      60 cm

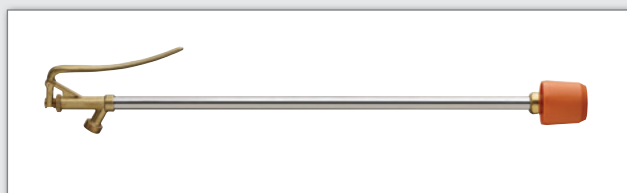

Confezioni minime 25 pz.  
Minimum quantity orders 25 pcs.

**Lancia a leva modello economico con testina ceramica**  
*Economical trigger spray gun with ceramic head*

CODICE • Code      MISURA • Size

77.F.E3C00      30 cm

77.F.E6C00      60 cm

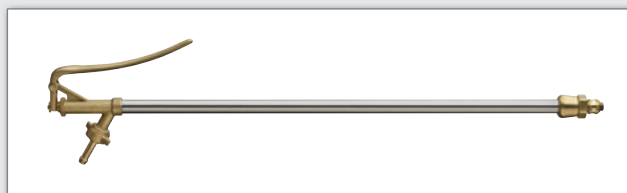

Confezioni minime 25 pz.  
Minimum quantity orders 25 pcs.

**Lancia a leva modello economico con portagomma**  
*Economical trigger spray gun with hose shank*

CODICE • Code      MISURA • Size

77.F.E3008      30 cm con portagomma Ø 8

77.F.E6008      60 cm con portagomma Ø 8

77.F.E3010      30 cm con portagomma Ø 10

77.F.E6010      60 cm con portagomma Ø 10



Confezioni minime 25 pz.  
Minimum quantity orders 25 pcs.

**Lancia a leva modello economico con testina inox e portagomma**  
*Economical trigger spray gun with inox head and hose shank*

CODICE • Code      MISURA • Size

77.F.E3108      30 cm con portagomma Ø 8

77.F.E6108      60 cm con portagomma Ø 8

77.F.E3110      30 cm con portagomma Ø 10

77.F.E6110      60 cm con portagomma Ø 10



Confezioni minime 25 pz.  
Minimum quantity orders 25 pcs.

### Lancia a leva modello economico con testina ceramica e portagomma

Economical trigger spray gun with ceramic head and hose shank

CODICE • Code      MISURA • Size

77.F.E3C08	30 cm con portagomma Ø 8
77.F.E6C08	60 cm con portagomma Ø 8
77.F.E3C10	30 cm con portagomma Ø 10
77.F.E6C10	60 cm con portagomma Ø 10

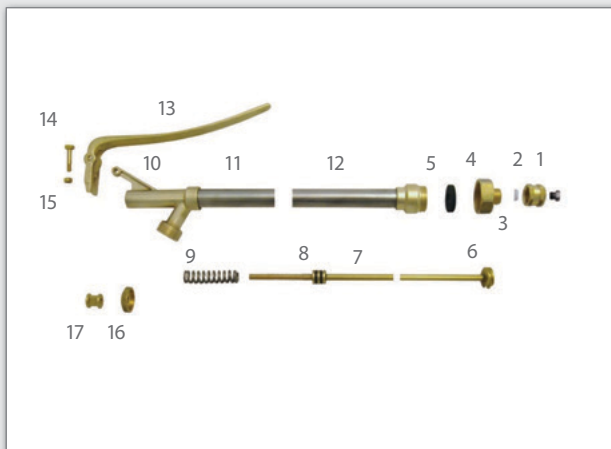

### Esploso lancia a leva modello economico

Economical trigger spray gun exploded

CODICE • Code

1	03.I.00015	Ugello inox • <i>Inox spray</i>
2	24.T.00002	Portaugello • <i>Spray support</i>
3	04.P.10653	Guarnizione tenuta ugello PTFE • <i>Rubber seal or PTFE</i>
4	29.T.12012	Calotta • <i>Hose</i>
5	04.P.09193	Guarnizione tenuta calotta • <i>Hose seal</i>
6	14.T.17006	Deviatore • <i>Switch</i>
7	45.T.50050	Asta • <i>Connection road</i>
8	01.K.00006	Or 6 N2 • <i>Seal 6 N2</i>
9	07.A.00077	Molla • <i>Spring</i>
10	00.T.00077	Corpo • <i>Body</i>
11	02.A.16047	Tubo acciaio • <i>Steel pipe</i>
12	59.T.23022	Camera di convogliamento • <i>Conveyment chamber</i>
13	09.T.00077	Maniglia ottone • <i>Brass handle</i>
14	08.T.04020	Vite M4 ottone • <i>Brass screw M4</i>
15	10.T.00000	Dado M4 ottone • <i>Brass hexagonal nut M4</i>
16	46.T.00001	Regolatore • <i>Pressure regulator</i>
17	47.T.00012	Distanziatore • <i>Spacer</i>



**Confezioni minime 25 pz.**  
Minimum quantity orders 25 pcs.

**Lancia manopola modello economico**  
Economical handle spray gun

CODICE • Code	MISURA • Size	PREZZO • Price
66.F.E3000	30 cm	€ 12,00
66.F.E6000	60 cm	€ 13,60



**Confezioni minime 25 pz.**  
Minimum quantity orders 25 pcs.

**Lancia manopola modello economico con testina inox**  
Economical handle spray gun with inox head

CODICE • Code	MISURA • Size
66.F.E3100	30 cm
66.F.E6100	60 cm

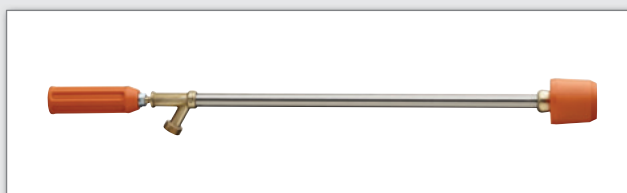

**Confezioni minime 25 pz.**  
Minimum quantity orders 25 pcs.

**Lancia manopola modello economico con testina ceramica**  
Economical handle spray gun with ceramic head

CODICE • Code	MISURA • Size
66.F.E3C00	30 cm
66.F.E6C00	60 cm



**Confezioni minime 25 pz.**  
Minimum quantity orders 25 pcs.

**Lancia manopola modello economico con portagomma**  
Economical handle spray gun with hose shank

CODICE • Code	MISURA • Size
66.F.E3008	30 cm con portagomma Ø 8
66.F.E6008	60 cm con portagomma Ø 8
66.F.E3010	30 cm con portagomma Ø 10
66.F.E6010	60 cm con portagomma Ø 10

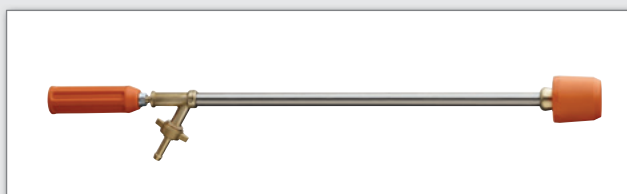

**Confezioni minime 25 pz.**  
Minimum quantity orders 25 pcs.

**Lancia manopola modello economico con testina inox e portagomma**  
Economical handle spray gun with inox head and hose shank

CODICE • Code	MISURA • Size
66.F.E3108	30 cm con portagomma Ø 8
66.F.E6108	60 cm con portagomma Ø 8
66.F.E3110	30 cm con portagomma Ø 10
66.F.E6110	60 cm con portagomma Ø 10



**Confezioni minime 25 pz.**  
Minimum quantity orders 25 pcs.

### Lancia manopola modello economico con testina ceramica e portagomma

*Economical handle spray gun with ceramic head and hose shank*

**CODICE** - Code      **MISURA** - Size

<b>66.F.E3C08</b>	30 cm con portagomma Ø 8
<b>66.F.E6C08</b>	60 cm con portagomma Ø 8
<b>66.F.E3C10</b>	30 cm con portagomma Ø 10
<b>66.F.E6C10</b>	60 cm con portagomma Ø 10



### Esploso lancia manopola modello economico

*Economical handle spray gun exploded*

**CODICE** - Code

1	<b>03.I.00015</b>	Ugello inox • <i>Inox spray</i>
2	<b>24.T.00002</b>	Portaugello • <i>Spray support</i>
3	<b>04.P.10653</b>	Guarnizione tenuta ugello PTFE • <i>Rubber seal or PTFE</i>
4	<b>29.T.23012</b>	Calotta • <i>Hose</i>
5	<b>04.P.09193</b>	Guarnizione tenuta calotta • <i>Hose seal</i>
6	<b>46.T.00001</b>	Convogliatore • <i>Conveyor</i>
7	<b>45.T.50010</b>	Asta • <i>Connection road</i>
8	<b>01.K.00006</b>	Or 6 N2 • <i>Seal 6 N2</i>
9	<b>08.T.12055</b>	Vite s/fine • <i>Worm</i>
10	<b>59.T.23022</b>	Camera di convogliamento • <i>Conveyment chamber</i>
11	<b>02.A.15008</b>	Tubo acciaio • <i>Steel pipe</i>
12	<b>00.T.00066</b>	Corpo • <i>Body</i>
13	<b>12.A.00008</b>	Dado M8 • <i>Nut M8</i>
14	<b>31.P.00000</b>	Manopola • <i>Handle</i>
15	<b>49.P.00000</b>	Tappo • <i>Plug</i>

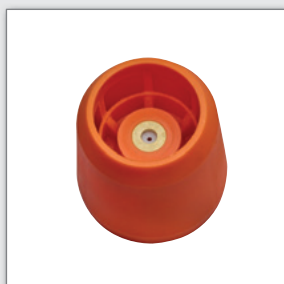

**Testina universale per lance ceramica**  
*Ceramic head*

**CODICE** • Code    **MISURA** • Size

<b>15.F.00C10</b>	Ø 1.0
<b>15.F.00C12</b>	Ø 1.2
<b>15.F.00C15</b>	Ø 1.5
<b>15.F.00C18</b>	Ø 1.8
<b>15.F.00C20</b>	Ø 2.0



**Testina universale per lance inox**  
*Inox head*

**CODICE** • Code    **MISURA** • Size

<b>15.F.00I10</b>	Ø 1.0
<b>15.F.00I12</b>	Ø 1.2
<b>15.F.00I15</b>	Ø 1.5
<b>15.F.00I18</b>	Ø 1.8
<b>15.F.00I20</b>	Ø 2.0



**Ghiera completa per lance modello economico**  
*Economical complete nut*

**Confezioni minime 25 pz.**  
*Minimum quantity orders 25 pcs.*

**CODICE** • Code    **MISURA** • Size

<b>35.F.5PE15</b>	Ø 1.5
<b>35.F.5PE18</b>	Ø 1.8



**Raccordo girevole**  
*Swivel connection*

**Confezioni minime 100 pz.**  
*Minimum quantity orders 100 pcs.*

**CODICE** • Code    **MISURA** • Size

<b>28.F.G1212</b>	1/2" m x 1/2" f
-------------------	-----------------

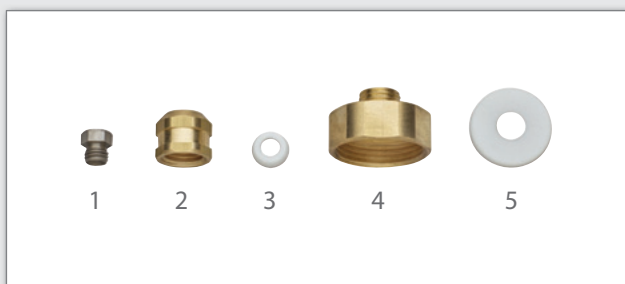

**Esploso ghiera completa per lance modello economico**  
*Economical spray gun nut exploded*

**CODICE** • Code

1	<b>03.I.00015</b>	Ugello inox • <i>Inox spray</i>
2	<b>24.T.00002</b>	Portaugello inox • <i>Spray support</i>
3	<b>04.P.10653</b>	Guarnizione tenuta ugello • <i>Rubber seal</i>
4	<b>29.T.12012</b>	Calotta • <i>Hose</i>
5	<b>04.P.09193</b>	Guarnizione tenuta calotta • <i>Hose seal</i>



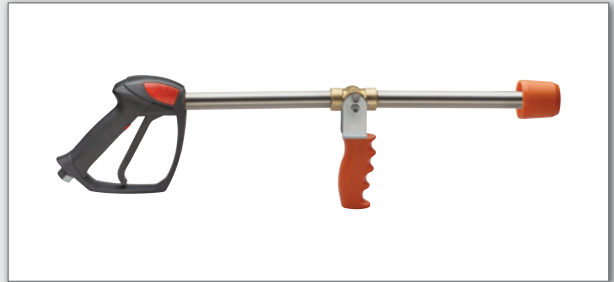
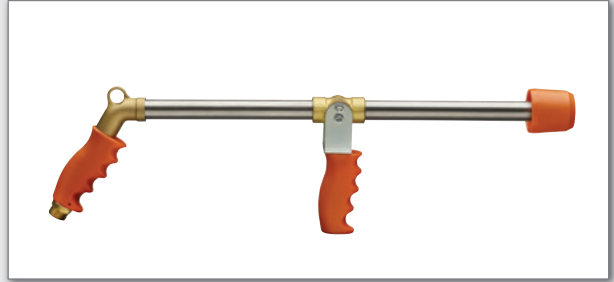
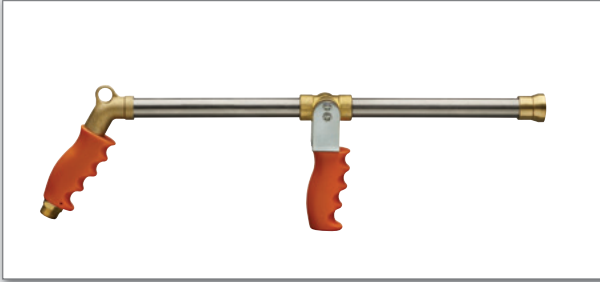

LANCE ALTA PRESSIONE  
40÷250 ATM  
Long range and  
washing spray guns





**Confezioni minime 10 pz.**  
Minimum quantity orders 10 pcs.

### Lancia mitra doppia

*Double spraying lance*

**CODICE** • Code

**80.F.DN000**



**Confezioni minime 10 pz.**  
Minimum quantity orders 10 pcs.

### Lancia mitra doppia con testina

*Double spraying lance with diffusor*

**CODICE** • Code

**80.F.DN015**



**Confezioni minime 10 pz.**  
Minimum quantity orders 10 pcs.

### Lancia mitra economica

*Economical spraying lance*

**CODICE** • Code

**80.F.EN000**



**Confezioni minime 10 pz.**  
Minimum quantity orders 10 pcs.

### Lancia mitra economica con testina

*Economical spraying lance with diffusor*

**CODICE** • Code

**80.F.EN015**

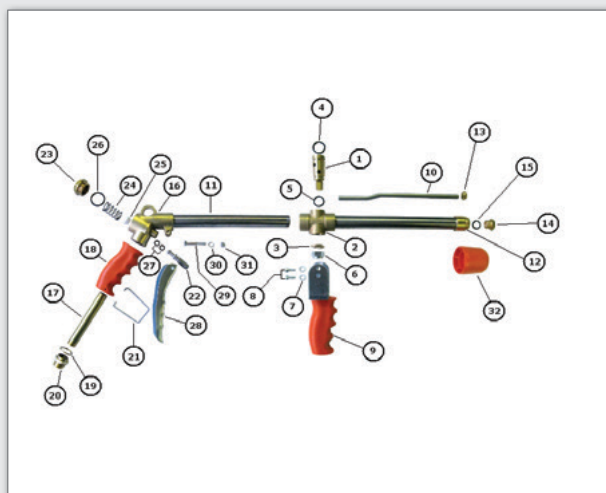

## Esploso lancia mitra

*Spraying lancer exploded*

### CODICE • Code

1	<b>43.T.00002</b>	Perno valvola intermedia • Intermediate valve's pin	17	<b>02.T.16106</b>	Tubo ottone 16x106 • Brass pipe 16x106
2	<b>00.T.00000</b>	Corpo valvola intermedia • Intermediate valve's body	18	<b>09.N.00003</b>	Manopola posteriore • Rear handle
3	<b>06.T.00000</b>	Rondella sagomata • Shaped brass ring	19	<b>06.T.25001</b>	Rondella 25x1 • Brass ring 25x1
4	<b>01.K.00013</b>	Or 13 • O-ring 13	20	<b>57.T.12016</b>	Attacco 1/2" • Connection 1/2"
5	<b>01.K.00011</b>	Or 11 • O-ring 11	21	<b>07.A.00150</b>	Molla sagomata • Shaped spring
6	<b>10.A.00012</b>	Dado autobloccante M12 • Locknut M12	22	<b>43.A.00001</b>	Perno inox D10 • Inox pin D10
7	<b>06.A.00006</b>	N°2 rondelle seghettate D6 • N°2 serrated brass rings	23	<b>49.T.00002</b>	Tappo premimolla • Brass plug
8	<b>08.A.06012</b>	N°2 viti M6x12 • N°2 screws M6x12	24	<b>07.A.00017</b>	Molla tenuta • Spring
9	<b>09.F.00002</b>	Manopola anteriore con forcella • Front handle with fork	25	<b>04.P.17100</b>	Guarnizione PTFE sagomata Shaped rubber seal PTFE
10	<b>02.A00002</b>	Tubo inox D8 piegato • Bending inox pipe D8	26	<b>01.K.00014</b>	Or 14 • O-ring 14
11	<b>02.F.22F20</b>	Tubo inox 22x1 filettato • Threaded inox pipe 22x1	27	<b>01.K.00006</b>	N°2 Or 6 • N°2 O-ring 6
12	<b>59.T.00001</b>	Camera di convogliamento • Conveyment chamber	28	<b>09.A.00003</b>	Maniglia zincata • Galvanized handle
13	<b>14.T.00000</b>	Convogliatore • Conveyor	29	<b>08.A.05035</b>	Vite M5x35 • Screw M5x35
14	<b>24.F.00000</b>	Portaugello con ugello ceramica Spray support with ceramic spray	30	<b>05.A.00005</b>	Rondella seghettata D5 • Serrated brass ring
15	<b>01.K.00009</b>	Or 9 • O-ring 9	31	<b>10.A.00005</b>	Dado autobloccante M5 • Locknut M5
16	<b>00.T.00022</b>	Corpo lancia doppia • Double spraying body	32	<b>15.P.0001+ 60.T.00002</b>	Testina + inserto • Diffusion + insert

Per questi particolari chiedere una quotazione al momento • For this quotations, please contact our office



**Confezioni minime 10 pz.**  
*Minimum quantity orders 10 pcs.*

### Lancia doppia corta con testina

*Short double spraying lancer with diffuser*

**CODICE** • Code

**80.F.C0015**



### Lancia mitra doppia regolazione con testina mobile

*Double regulation spray gun with adjustable air mixing diffuser*

**CODICE** • Code

**80.F.M0015**



**Confezioni minime 10 pz.**  
*Minimum quantity orders 10 pcs.*

### Pistola lavaggio/diserbo regolabile

*Adjustable washing and spraying gun*

**CODICE** • Code

**80.F.LN015**



### Pistola irrorazione regolabile ugello diametro 1,5 mm

*Adjustable spraying gun ceramic spray tip diameter 1,5 mm*

**CODICE** • Code

**80.F.T0015**

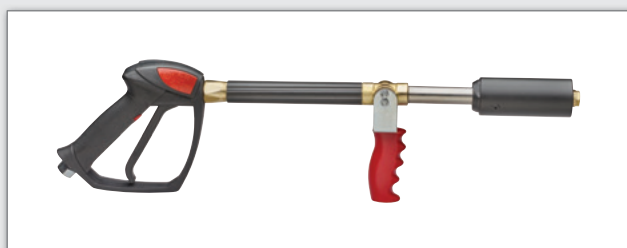

CODICE - Code

80.F.AN001

### Lancia doppia regolazione con testa mobile lunga gittata attacco 1/4" G F

Long range double regulation spray gun with adjustable air mixing diffuser

#### Specifiche tecniche • Technical specifications

PRESSIONE DI ESERCIZIO Operating pressure	max 150 bar - 2175 psi
PORTATA MAX Max flow rate	40 l/m
GITTATA MAX Max range	15 m/nozzle
Ø UGELLO STANDARD Standard nozzle	Ø 3,0 mm



CODICE - Code

80.F.AN004

### Pistola doppia regolazione alta pressione attacco 1/4" G F

High pressure double regulation spray gun

#### Specifiche tecniche • Technical specifications

PRESSIONE DI ESERCIZIO Operating pressure	max 150 bar - 2175 psi
PORTATA MAX Max flow rate	40 l/m
GITTATA MAX Max range	13 m/nozzle
Ø UGELLO STANDARD Standard nozzle	Ø 2,2 mm



### Blocco intermedio con diffusore mobile attacco 1/4" gas M

1/4" BSPM middle black block with adjustable air mixing diffuser

CODICE - Code

80.F.AN003

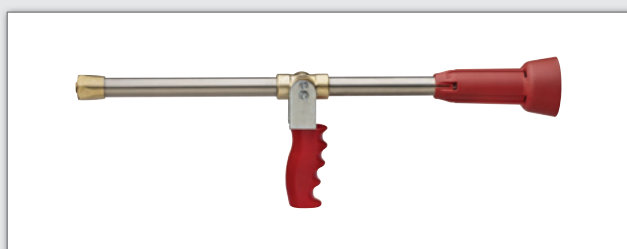

### Blocco intermedio con diffusore attacco 1/4" gas M

1/4" BSPM middle red block with adjustable air mixing diffuser

CODICE - Code

80.F.AN006

LANCE ALTA PRESSIONE  
40÷250 ATM  
Long range and  
washing spray guns



**Blocco intermedio lancia fissa  
attacco 1/4" gas M**

1/4" BSPM middle block with fixed air mixing diffusor

CODICE • Code

80.F.AN005

**Accessori disponibili**

Available equipment



**Diffusore  
nebulizzante  
per lance mitra**

Nebulizing diffusor  
for mitra spraying gun

CODICE • Code

15.F.00080



**Ugello  
di ricambio**

Spray tips

CODICE • Code

24.F.00R23



**Pistola multiuso tre fasi  
attacco 1/4" G F**

Multipurpose triple nozzle spray gun

Specifiche tecniche • Technical specifications

PRESSIONE DI ESERCIZIO  
Operating pressure

max 250 bar - 3626 psi  
ugelli a cono/ventaglio  
e schiumogeno

CODICE • Code

80.F.AN000



**Trombocino tre fasi  
intercambiabile completo  
di attacco rapido attacco  
G 3/8" F**

3/8" BSPF interchangeable  
multipurpose triple nozzle  
sprayer with fast joint,  
without handle

CODICE • Code

80.F.AN008



**Impugnatura ergonomica  
con fermo di sicurezza della  
leva contro aperture  
accidentali e protezione  
della mano a norma ISO/EN**

Ergonomic heavy duty handle  
with a trigger lock to prevent  
accidental opening according  
to ISO/EN safety rules

CODICE • Code

80.F.AN100

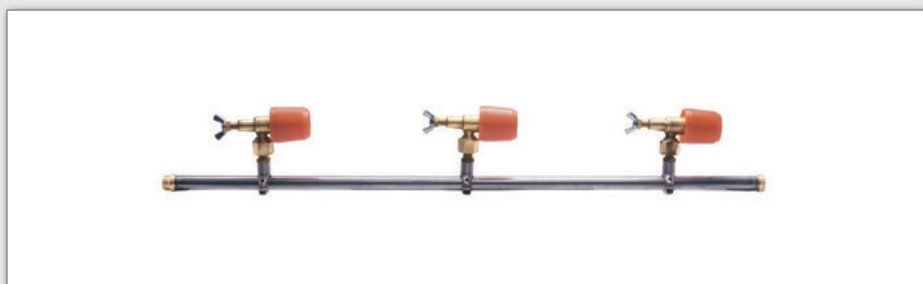
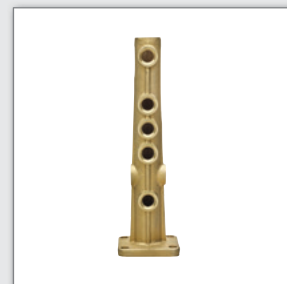
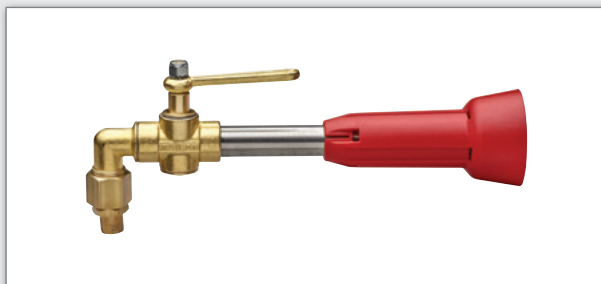



Confezioni minime 10 pz.  
Minimum quantity orders 10 pcs.

### Nebulizzatore inox curvo con attacco 3/8" con ugello a rosa

*Stainless steel sprayer 3/8" with wide spraying outlet*

CODICE • Code

69.F.A0R10

69.F.A0R12

69.F.A0R15

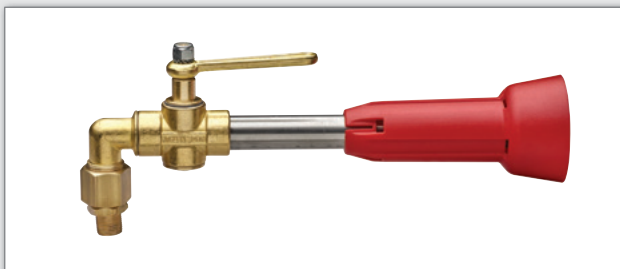

Confezioni minime 10 pz.  
Minimum quantity orders 10 pcs.

### Nebulizzatore inox curvo con att. 3/8" con ugello a rosa e testina

*Stainless steel sprayer 3/8" w/ wide spraying outlet and diffusor*

CODICE • Code

69.F.15R10

69.F.15R12

69.F.15R15

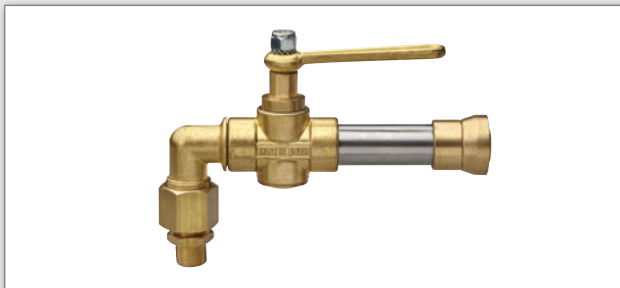

Confezioni minime 10 pz.  
Minimum quantity orders 10 pcs.

### Nebulizzatore curvo con attacco 3/8" con ugello a rosa

*Stainless sprayer 3/8" with wide spraying outlet*

CODICE • Code

69.F.T0R10

69.F.T0R12

69.F.T0R15

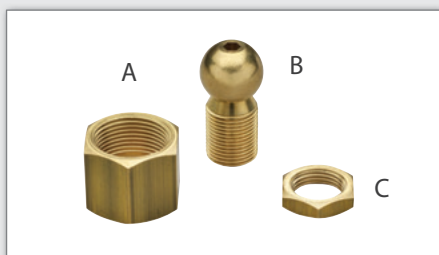

### Ricambi

Spare parts

#### CODICE • Code

<b>A 10.T.02415</b>	Dado bloccaggio 24x1,5 • <i>Blocking nut</i>
<b>B 22.T.00000</b>	Snodo sferico 3/8" • <i>Ball joint 3/8"</i>
<b>C 12.T.00000</b>	Controdado 3/8" • <i>Lock nut 3/8"</i>



### Ricambi

Spare parts

#### CODICE • Code

<b>24.F.00R08</b>	Portaugello c/ ugello ceramica a rosa foro 0.8 <i>Spray support w/ wide spraying sprayer 0.8</i>
<b>24.F.00R10</b>	Portaugello c/ ugello ceramica a rosa foro 1.0 <i>Spray support w/ wide spraying sprayer 1.0</i>
<b>24.F.00R12</b>	Portaugello c/ ugello ceramica a rosa foro 1.2 <i>Spray support w/ wide spraying sprayer 1.2</i>
<b>24.F.00R15</b>	Portaugello c/ ugello ceramica a rosa foro 1.5 <i>Spray support w/ wide spraying sprayer 1.5</i>
<b>24.F.00R18</b>	Portaugello c/ ugello ceramica a rosa foro 1.8 <i>Spray support w/ wide spraying sprayer 1.8</i>
<b>24.F.00R20</b>	Portaugello c/ ugello ceramica a rosa foro 2.0 <i>Spray support w/ wide spraying sprayer 2.0</i>
<b>24.F.00R25</b>	Portaugello c/ ugello ceramica a rosa foro 2.5 <i>Spray support w/ wide spraying sprayer 2.5</i>
<b>24.F.00R30</b>	Portaugello c/ ugello ceramica a rosa foro 3.0 <i>Spray support w/ wide spraying sprayer 3.0</i>

**Confezioni minime 10 pz.**  
*Minimum quantity orders 10 pcs.*



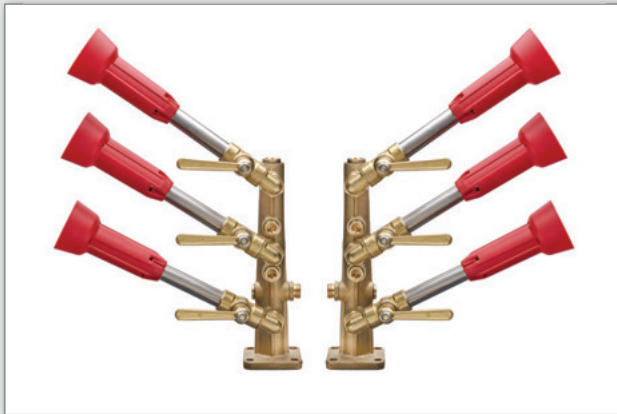

### Colonnina singola completa di 3 nebulizzatori con testina

Single stud with 3 bended sprayers with diffusers

CODICE • Code      MISURA • Size

40.F.69R10      ugello a rosa ø 1.0

40.F.69R12      ugello a rosa ø 1.2

40.F.69R15      ugello a rosa ø 1.5



### Colonnina 7 uscite

Connector with 7 outlets

CODICE • Code

40.F.00000

Confezioni minime 10 pz.  
Minimum quantity orders 10 pcs.

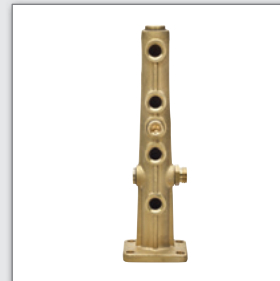

### Colonnina 7 uscite completa di tappi e niple

7 outlets connector complete with plugs and nipples

CODICE • Code

40.F.00001

Confezioni minime 10 pz.  
Minimum quantity orders 10 pcs.

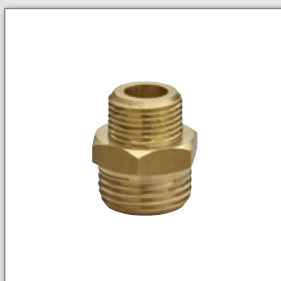

### Riduzione

Reduction

Confezioni minime 100 pz.  
Minimum quantity orders 100 pcs.

CODICE • Code      MISURA • Size

53.T.01238      1/2"x3/8"

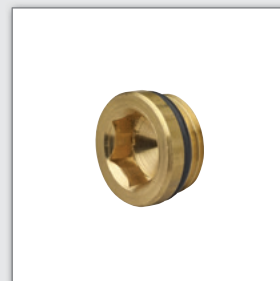

### Tappo completo di OR

Plug complete with OR seal

Confezioni minime 100 pz.  
Minimum quantity orders 100 pcs.

CODICE • Code      MISURA • Size

49.F.00012      1/2"

49.F.00038      3/8"



### Piastra zincata supporto a colonnine completa di viti e guarnizioni

Zinc-coated support plate for connector with screws and nuts

CODICE • Code

98.F.00004

Confezioni minime 10 pz.  
Minimum quantity orders 10 pcs.



### Aggitatore curvo con girello

Multi sprayer with bended hose

**CODICE** • Code      **MISURA** • Size

**71.F.C0008**      ø 8

**71.F.C0010**      ø 10

**Confezioni minime 10 pz.**  
Minimum quantity orders 10 pcs.



### Aggitatore diritto con portagomma e girello

Multi sprayer with hose and nut

**CODICE** • Code      **MISURA** • Size

**71.F.D0008**      ø 8

**71.F.D0010**      ø 10

**Confezioni minime 10 pz.**  
Minimum quantity orders 10 pcs.



### Aggitatore

Multi sprayer

**CODICE** • Code

**71.F.00001**

**Confezioni minime 10 pz.**  
Minimum quantity orders 10 pcs.

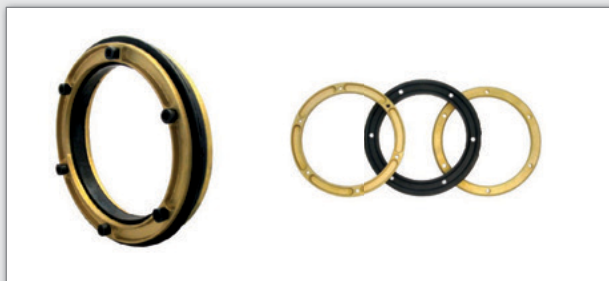

### Serie flange oblò atomizzatori

Complete set of double flanges

**Confezioni minime 10 pz.**  
Minimum quantity orders 10 pcs.

**CODICE** • Code

**72.F.00003**      1 flange oblò forato + 1 flange oblò filettato + 1 guarnizione • 1 brass drilled ring + 1 threaded brass ring + 1 seal

**72.F.00004**      2 flange oblò forato + 2 flange oblò filettato • 2 brasses drilled ring + 2 threaded brasses ring

**72.F.00006**      2 flange oblò forato + 2 flange oblò filettato + 2 guarnizioni • 2 brasses drilled ring + 2 threaded brasses ring + 2 seals



### Asta con getti farfalla

Connecting rod with "T" sprayers

**CODICE** • Code

**MISURA** • Size

<b>45.F.67C08</b>	Asta con getti farfalla con testina ceramica • Connecting rod with "T" sprayer and ceramic head	cm. 80 x 3
<b>45.F.67C10</b>	Asta con getti farfalla con testina ceramica • Connecting rod with "T" sprayer and ceramic head	cm. 100 x 4
<b>45.F.67C12</b>	Asta con getti farfalla con testina ceramica • Connecting rod with "T" sprayer and ceramic head	cm. 120 x 5
<b>45.F.67C14</b>	Asta con getti farfalla con testina ceramica • Connecting rod with "T" sprayer and ceramic head	cm. 140 x 5
<b>45.F.67I08</b>	Asta con getti farfalla con testina inox • Connecting rod with "T" sprayer and inox head	cm. 80 x 3
<b>45.F.67I10</b>	Asta con getti farfalla con testina inox • Connecting rod with "T" sprayer and inox head	cm. 100 x 4
<b>45.F.67I12</b>	Asta con getti farfalla con testina inox • Connecting rod with "T" sprayer and inox head	cm. 120 x 5
<b>45.F.67I14</b>	Asta con getti farfalla con testina inox • Connecting rod with "T" sprayer and inox head	cm. 140 x 5

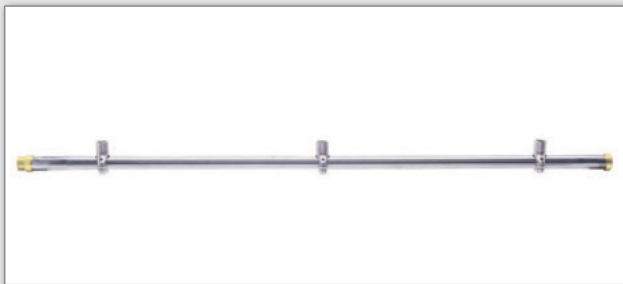

### Asta con morsetti

Clamp stem

**CODICE** • Code

**MISURA** • Size

<b>45.F.80003</b>	cm. 80 x 3
<b>45.F.10004</b>	cm. 100 x 4
<b>45.F.12005</b>	cm. 120 x 5
<b>45.F.14005</b>	cm. 140 x 5



### Getto farfalla con testine

"T" sprayer

**Confezioni minime 10 pz.**  
Minimum quantity orders 10 pcs.

**CODICE** • Code

**MISURA** • Size

<b>67.F.15C10</b>	Getto farfalla con testina ceramica • "T" sprayer with ceramic head	foro 1.0
<b>67.F.15C12</b>	Getto farfalla con testina ceramica • "T" sprayer with ceramic head	foro 1.2
<b>67.F.15I10</b>	Getto farfalla con testina inox • "T" sprayer with inox head	foro 1.0
<b>67.F.15I12</b>	Getto farfalla con testina inox • "T" sprayer with inox head	foro 1.2
<b>67.F.15I15</b>	Getto farfalla con testina inox • "T" sprayer with inox head	foro 1.5



**Getto farfalla inox/ceramica**
*Inox/ceramic "T" sprayer*
**Confezioni minime 10 pz.**  
*Minimum quantity orders 10 pcs.*
**CODICE** • Code

**MISURA** • Size

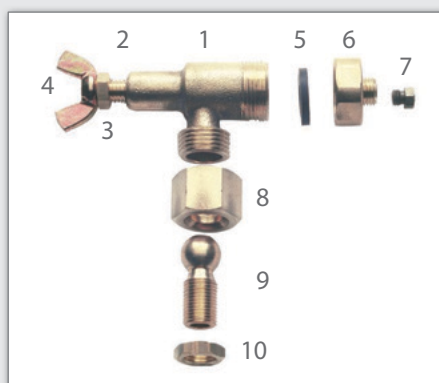
<b>67.F.00C10</b>	Getto farfalla con ugello ceramica • "T" sprayer with ceramic hose	foro 1.0
<b>67.F.00C12</b>	Getto farfalla con ugello ceramica • "T" sprayer with ceramic hose	foro 1.2
<b>67.F.00I10</b>	Getto farfalla con ugello inox • "T" sprayer with inox hose	foro 1.0
<b>67.F.00I12</b>	Getto farfalla con ugello inox • "T" sprayer with inox hose	foro 1.2

**Esploso getti farfalla**
*"T" sprayer exploded*
**CODICE** • Code

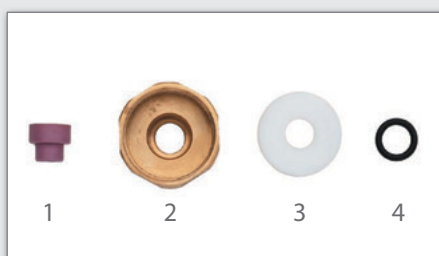
<b>1</b>	<b>00.T.00001</b>	Corpo • Body
<b>2</b>	<b>14.T.00001</b>	Convogliatore getto farfalla • "T" sprayer conveyor
<b>3</b>	<b>12.T.00010</b>	Controdado M 10 • Joint M10
<b>4</b>	<b>10.A.00002</b>	Dado ad alette • Fly nut
<b>5</b>	<b>04.P.09233</b>	Guarnizione calotta • Hose seal
<b>6</b>	<b>29.T.00001</b>	Calotta M7 • Hose M7
<b>7</b>	<b>03.I.00010</b>	Ugello inox • Inox spray
<b>8</b>	<b>10.T.00001</b>	Dado bloccaggio 1/2" gas • Blocking nut 1/2"
<b>9</b>	<b>22.T.00001</b>	Snodo sferico 1/4" gas • Ball joint 1/4" gas
<b>10</b>	<b>12.T.00001</b>	Controdado 1/4" gas • Joint 1/4" gas

**Esploso ghiera completa per getti a farfalla**
*Nut for "T" sprayer exploded*
**CODICE** • Code

**MISURA** • Size

<b>35.F.4P012</b>	Ghiera completa per getti a farfalla ø 12 Nut for "T" sprayer ø 12		
<b>35.F.4P015</b>	Ghiera completa per getti a farfalla ø 15 Nut for "T" sprayer ø 15		
<b>1</b>	<b>03.C.GF010</b>	Ugello ceramica a rosa ø 11 Ceramic sprayer ø 11	foro 1.0
<b>2</b>	<b>29.T.00000</b>	Calotta per ceramica • Hose for ceramic	
<b>3</b>	<b>04.P.09233</b>	Guarnizione calotta • Hose seal	
<b>4</b>	<b>01.K.00006</b>	Or 6 • Seal 6	

**Confezioni minime 10 pz.**  
*Minimum quantity orders 10 pcs.*



### Morsetto con viti e guarnizioni

Clamp with cap, stainless steel screws and o ring

Confezioni minime 100 pz.  
Minimum quantity orders 100 pcs.

CODICE • Code      MISURA • Size

73.F.14021      ø 21

73.F.14020      ø 20



### Morsetto irrorante c/ viti e guarnizioni

Spraying clamp with cap, stainless steel screws and o ring

Confezioni minime 100 pz.  
Minimum quantity orders 100 pcs.

CODICE • Code      MISURA • Size

73.F.38021      ø 21

73.F.38020      ø 20



### Testina ceramica

Ceramic protection

CODICE • Code      MISURA • Size

15.F.00C10      ø 1.0

15.F.00C12      ø 1.2

15.F.00C15      ø 1.5

15.F.00C18      ø 1.8

15.F.00C20      ø 2.0

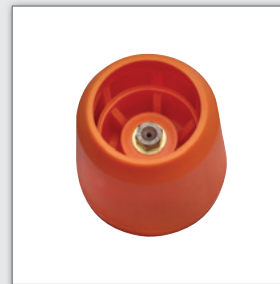

### Testina inox

Inox protection

CODICE • Code      MISURA • Size

15.F.00I10      ø 1.0

15.F.00I12      ø 1.2

15.F.00I15      ø 1.5

15.F.00I18      ø 1.8

15.F.00I20      ø 2.0

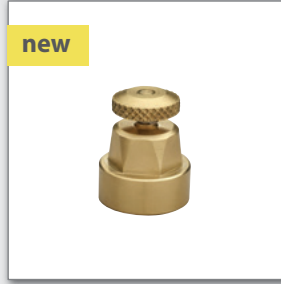



**Getto diserbo doppio attacco 1/4" M gas con ugelli**

*1/4" BSPM double nozzle with spray tips*

**CODICE** • Code    **MISURA** • Size

**67.F.40C00**    1/4"



**Getto diserbo doppio attacco 1/4" M gas senza ugelli**

*1/4" BSPM double nozzle with caps - spray tips not included*

**CODICE** • Code    **MISURA** • Size

**67.F.40000**    1/4"



**Getto diserbo doppio attacco 1/4" gas femmina con ugelli**

*1/4" BSPF double nozzle with caps and spray tips*

**CODICE** • Code    **MISURA** • Size

**67.F.45C00**    1/4"



**Getto diserbo doppio attacco 3/8" M x 3/8" F c.u.**

*3/8" BSPM x 3/8" BSPF double nozzle with caps and spray tips*

**CODICE** • Code    **MISURA** • Size

**67.F.50C00**    3/8"



**Testa regolabile per getti diserbo con ugello**

*Adjustable head for nozzles with spray tips*

**CODICE** • Code

**67.F.60C00**

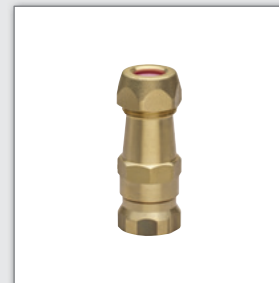

**Testa regolabile per getti diserbo senza ugello**

*Adjustable head for nozzles with caps - spray tips not included*

**CODICE** • Code

**67.F.60000**



**Getto diserbo doppio con testa regolabile attacco 1/4" G M**

*1/4" BSPM double nozzle with adjustable head*

**CODICE** • Code    **MISURA** • Size

**67.F.70CM0**    1/4"



**Getto diserbo doppio con testa regolabile attacco 1/4" G F**

*1/4" BSPF double nozzle with adjustable head*

**CODICE** • Code    **MISURA** • Size

**67.F.70CF0**    1/4"



**Valvola antigoccia per getti attacco 1/4" gas M x 1/4" gas F**

1/4" BSPM x 1/4" BSPF check valve for nozzles

**CODICE** • Code    **MISURA** • Size

**67.F.80000**    1/4"

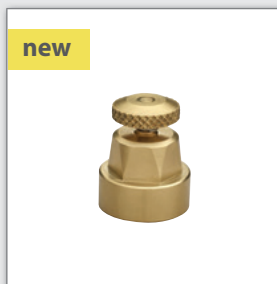

new

**Valvola chiusura antigoccia**

Check valve locker

**CODICE** • Code

**67.F.90000**

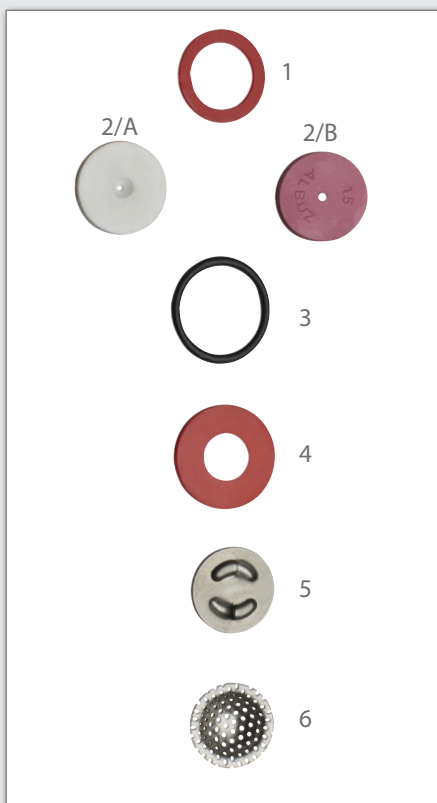

**Pezzi di ricambio**

Spare parts

**CODICE** • Code

<b>1</b>	<b>04.P.18008</b>	Guarnizione • Seal for ceramics tips
<b>2/A</b>	<b>03.C.18010</b>	Piastrina ceramica • Ceramic tips
<b>2/B</b>	<b>03.C.18010</b>	Piastrina ceramica • Ceramic tips
<b>3</b>	<b>01.K.02068</b>	Or tenuta • Or
<b>4</b>	<b>04.P.20002</b>	Guarnizione testa • Gasket
<b>5</b>	<b>14.F.17006</b>	Convogliatore inox • Inox Core
<b>6</b>	<b>13.A.17005</b>	Filtrino inox • Stainless steel filter





### Aste inox AISI 304 per barre da diserbo e irrorazione

Diametro del tubo, lunghezza e raggi degli archi, fori e filetti vengono prodotti a misura su disegno del cliente

*Aisi 304 stainless steel rods for spraying booms*

*Diameter, size, holes and thread of stainless steel rods are custom-made according to draw*

**Confezioni minime 100 pz.**  
*Minimum quantity orders 100 pcs.*



### Aste curve inox 304 per gruppi ventola

Diametro del tubo, lunghezza e raggi degli archi, fori e filetti vengono prodotti a misura su disegno del cliente

*Aisi 304 stainless steel curved rods for ventilating fan units*

*Diameter, size, radius of arc, holes and thread of stainless steel rods are custom-made according to draw*

**Confezioni minime 100 pz.**  
*Minimum quantity orders 100 pcs.*

### Accessori per aste e archi

*Spare parts for Aisi 304 stainless steel curved rods*



#### Morsetto con viti e guarnizioni

*Clamp with cap, stainless steel screws and o ring*

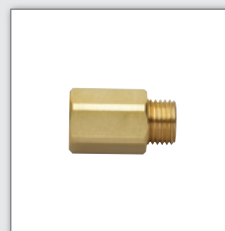

#### Riduzione 1/4"x1/4"

*Reduction 1/4"x1/4"*



#### Portagomma 2 pz con dado

*Heavy combined 2 pc hose with hexagonal nut*

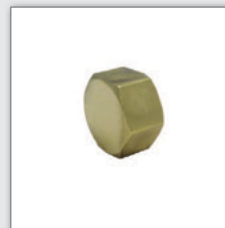

#### Tappo esagonale 23x1/2"

*Hexagonal plug 23x1/2"*





Solo su ordinazione

**Giunto girevole 1/2" femmina x1/2" femmina  
con portagomma 8-10-13**

*Swivel coupling 1/2" f x 1/2" f with hose shank 8-10-13*

**CODICE** • Code

**85.F.00012**

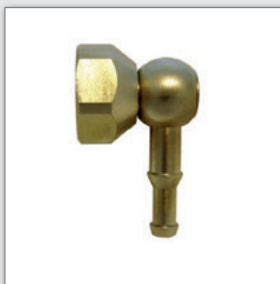

Solo su ordinazione

**Giunto girevole 3/4" femmina 8-10**

*Swivel coupling 3/4" f with double hose shank 8-10*

**CODICE** • Code

**85.F.00034**



Solo su ordinazione

**Giunto girevole 3/8" maschio  
con portagomma doppio 8-10**

*Swivel joint for hose reels 3/8" m with double hose shank 8-10*

**CODICE** • Code

**85.F.00038**



Solo su ordinazione

**Giunto girevole 1" curvo 90°**

*90° swivel coupling 1"*

**CODICE** • Code

**85.F.00001**

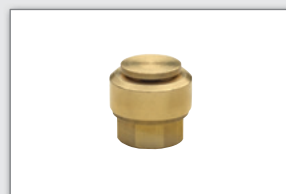



**Irrigatore "Cris"**  
**circolare bigetto 1" - 1/4" femmina**  
*Irrigator "Cris" 1" - 1/4" female circular - 2 jet*

**CODICE** - Code

**70.F.CB114**

Irrigatore due getti di media portata circolare e settore regolabile. I due getti, con diversa inclinazione, sono dotati di ugelli intercambiabili e di rompigetti a penetrazione regolabile, che permettono precipitazioni fini e localizzate a piacimento. E' adatto per qualsiasi tipo di impianto e si presta per terreni di qualsiasi natura ed estensione.

**Confezioni minime 10 pz.** • Minimum quantity orders 10 pcs.

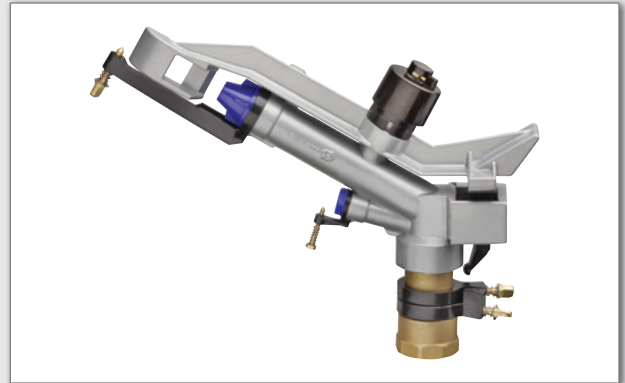

**Irrigatore "Cris"**  
**settore bigetto 1" - 1/4" femmina**  
*Irrigator "Cris" 1" - 1/4" female sector - 2 jet*

**CODICE** - Code

**70.F.SB114**

Middle flow rate double-jet circular irrigator or with adjustable sector. The two jets, slanting in a different way, are provided with interchangeable nozzles and adjustable-penetration jetbreakers which allow fine and uniformly distributed precipitations. It is suitable for any type of sistem and fit for grounds of any sort and extent.

**Confezioni minime 10 pz.** • Minimum quantity orders 10 pcs.

U Diametro ugello Nozzle Diameter	P Pressione Pressure	G Gittata Jet lenght	Q Portata Capacity		● Dati relativi ad un irrigatore Values for a single sprinkler		■ Disposizione in quadrato Square pattern			▲ Disposizione in triangolo Triangular pattern			
					S Superficie irrigata Irrigated area	I Intensità oraria Rainfall per hour	D Distanza irrigatori sull'ala piovana Distance of the sprinklers on the pipeline	S Superficie irrigata Irrigated area	I Intensità oraria Rainfall per hour	D Distanza irrigatori sull'ala piovana contigue Distance of the sprinklers on the pipeline	D <sub>1</sub> Distanza tra 2 ali piovane contigue Distance between 2 conti- guous pipelines	S Superficie irrigata Irrigated area	I Intensità oraria Rainfall per hour
mm	atm	m	l/m	m <sup>3</sup> /h	m <sup>2</sup>	mm/h	m	m <sup>2</sup>	mm/h	m	m	m <sup>2</sup>	mm/h
7,5 — 4	1,5	16,5	62	3,7	855	4,3	23	529	7	28	24	672	5,5
	2	17,5	71	4,2	962	4,4	24	576	7,3	30	26	780	5,4
	3	19,5	87	5,2	1194	4,3	27	729	7,1	33	29	957	5,4
	4	21	100	6	1384	4,3	29	841	7,1	36	31	1116	5,4
8 — 4	1,5	17	76	4,5	908	4,9	24	576	7,8	29	25	725	6,2
	2	18	88	5,3	1017	5,2	25	625	8,5	31	27	837	6,3
	3	20	107	6,4	1256	5	28	784	8,2	34	30	1020	6,3
	4	21,5	124	7,4	1451	5	30	900	8,2	37	32	1184	6,2
10 — 4	2	19	106	6,4	1134	5,6	26	676	9,5	32	28	896	7,1
	3	21	130	7,8	1384	5,6	29	841	9,3	36	31	1116	7
	4	22,5	151	9	1590	5,7	32	1024	8,8	39	34	1326	6,8
	5	23,5	170	10,2	1734	5,9	33	1089	9,3	40	35	1400	7,3
12 — 4	2	21	149	8,9	1384	6,4	29	841	10,6	36	31	1116	8
	3	23,5	182	10,9	1734	6,3	33	1089	10	40	35	1400	7,8
	4	26	211	12,6	2123	5,9	36	1296	9,7	44	39	1716	7,3
	5	28	236	14,2	2461	5,8	39	1521	9,3	48	42	2016	7

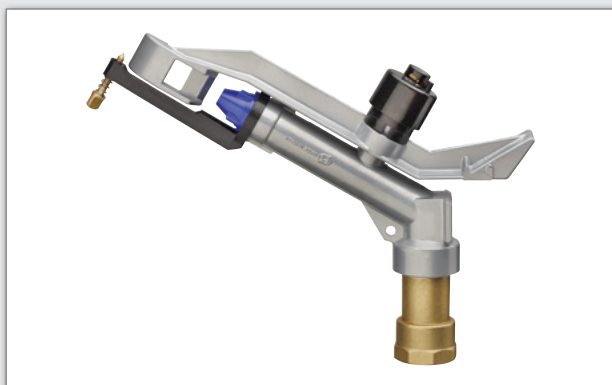

**Irrigatore "Falcon"  
circolare 1" - 1/4" femmina**

*Irrigator "Falcon" 1" 1/4" female circular*

**CODICE** - Code

**70.F.C0114**

Irrigatore di media portata circolare e settore regolabile. E' dotato di ugelli intercambiabili e di rompighetto a penetrazione regolabile, che permettono precipitazione fine uniformemente distribuita. E' adatto per qualsiasi tipo di impianto e si presta per terreni di qualsiasi natura ed estensione.

**Confezioni minime 10 pz.** - Minimum quantity orders 10 pcs.



**Irrigatore "Falcon"  
settore 1" - 1/4" femmina**

*Irrigator "Falcon" 1" 1/4" female sector*

**CODICE** - Code

**70.F.S0114**

Middle flow rate circular irrigator or with adjustable sector. It is provided with interchangeable nozzles and adjustable penetration jet-breaker which allow a fine and uniformly distributed precipitation. It is suitable for any type of sistem and fit for grounds of any sort and extent.

**Confezioni minime 10 pz.** - Minimum quantity orders 10 pcs.

U Diametro ugello Nozzle Diameter	P Pressione Pressure	G Gittata Jet length	Q Portata Capacity		● Dati relativi ad un irrigatore Values for a single sprinkler		■ Disposizione in quadrato Square pattern			▲ Disposizione in triangolo Triangular pattern			
					S Superficie irrigata Irrigated area	I Intensità oraria Rainfall per hour	D Distanza irrigatori sull'ala piovana Distance of the sprinklers on the pipeline	S Superficie irrigata Irrigated area	I Intensità oraria Rainfall per hour	D Distanza irrigatori sull'ala piovana Distance of the sprinklers on the pipeline	D <sub>1</sub> Distanza tra 2 ali piovane contigue Distance between 2 contiguous pipelines	S Superficie irrigata Irrigated area	I Intensità oraria Rainfall per hour
mm	atm	m	l/m	m <sup>3</sup> /h	m <sup>2</sup>	mm/h	m	m <sup>2</sup>	mm/h	m	m	m <sup>2</sup>	mm/h
7,5	1,5	15,5	49	2,9	754	3,8	22	484	6	26	23	598	4,8
	2	17	57	3,4	908	3,7	24	576	5,9	29	25	725	4,7
	3	19	69	4,1	1134	3,6	26	676	6	32	28	896	4,6
	4	20,5	80	4,8	1319	3,6	29	841	5,7	35	30	1050	4,5
8	1,5	16,5	62	3,7	855	4,3	23	529	7	28	24	672	5,5
	2	17,5	71	4,2	962	4,3	24	576	7,3	30	26	780	5,4
	3	19,5	87	5,2	1194	4,3	27	729	7,1	33	29	957	5,4
	4	21	100	6	1384	4,3	29	841	7,1	36	31	1116	5,3
10	1,5	17	76	4,5	908	4,9	24	576	7,8	29	25	725	6,2
	2	18	88	5,3	1017	5,2	25	625	8,4	31	27	837	6,3
	3	20,5	107	6,4	1319	4,8	29	841	7,6	35	30	1050	6,1
	4	22	124	7,4	1520	4,8	31	961	7,7	38	33	1254	5,9
12	1,5	17	110	6,6	908	7,2	24	576	11,4	29	25	725	9,1
	2	19	127	7,6	1134	6,7	26	676	11,2	32	28	896	8,5
	3	21	155	9,3	1384	6,7	29	841	11	36	31	1116	8,3
	4	23,5	179	10,7	1734	6,2	33	1089	9,8	40	35	1400	7,6



### Irrigatore "Gulliver" settoe 1"1/2" bigetto femmina

Irrigator "Gulliver" 1" 1/2" female sector - 2 jet

**CODICE** - Code

**70.F.SB112**

Irrigatore due getti di media portata circolare e settoe regolabile. I due getti, con diversa inclinazione, sono dotati di ugelli intercambiabili e di rompighetti a penetrazione regolabile, che permettono precipitazioni fini e localizzate a piacimento. E' adatto per qualsiasi tipo di impianto e si presta per terreni di qualsiasi natura ed estensione.

**Confezioni minime 10 pz.** • Minimum quantity orders 10 pcs.



### Irrigatore "Gulliver" circolare bigetto 1" 1/2" femmina

Irrigator "Gulliver" 1" 1/2" female circular - 2 jet

**CODICE** - Code

**70.F.CB112**

Middle flow rate double-jet circular irrigator or with adjustable sector. The two jets, slanting in a different way, are provided with interchangeable nozzles and adjustable-penetration jetbreakers which allow fine and uniformly distributed precipitations. It is suitable for any type of sistem and fit for grounds of any sort and extent.

**Confezioni minime 10 pz.** • Minimum quantity orders 10 pcs.

U Diametro ugello Nozzle Diameter	P Pressione Pressure	G Gittata Jet length	Q Portata Capacity		● Dati relativi ad un irrigatore Values for a single sprinkler		■ Disposizione in quadrato Square pattern			▲ Disposizione in triangolo Triangular pattern			
					S Superficie irrigata Irrigated area	I Intensità oraria Rainfall per hour	D Distanza irrigatori sull'ala piovana Distance of the sprinklers on the pipeline	S Superficie irrigata Irrigated area	I Intensità oraria Rainfall per hour	D Distanza irrigatori sull'ala piovana Distance of the sprinklers on the pipeline	D <sub>1</sub> Distanza tra 2 ali piovane contigue Distance between 2 conti- guous pipelines	S Superficie irrigata Irrigated area	I Intensità oraria Rainfall per hour
mm	atm	m	l/m	m <sup>3</sup> /h	m <sup>2</sup>	mm/h	m	m <sup>2</sup>	mm/h	m	m	m <sup>2</sup>	mm/h
7,5 — 4	1,5	16,5	62	3,7	855	4,3	23	529	7	28	24	672	5,5
	2	17,5	71	4,2	962	4,4	24	576	7,3	30	26	780	5,4
	3	19,5	87	5,2	1194	4,3	27	729	7,1	33	29	957	5,4
	4	21	100	6	1384	4,3	29	841	7,1	36	31	1116	5,4
8 — 4	1,5	17	76	4,5	908	4,9	24	576	7,8	29	25	725	6,2
	2	18	88	5,3	1017	5,2	25	625	8,5	31	27	837	6,3
	3	20	107	6,4	1256	5	28	784	8,2	34	30	1020	6,3
	4	21,5	124	7,4	1451	5	30	900	8,2	37	32	1184	6,2
10 — 4	2	19	106	6,4	1134	5,6	26	676	9,5	32	28	896	7,1
	3	21	130	7,8	1384	5,6	29	841	9,3	36	31	1116	7
	4	22,5	151	9	1590	5,7	32	1024	8,8	39	34	1326	6,8
	5	23,5	170	10,2	1734	5,9	33	1089	9,3	40	35	1400	7,3
12 — 4	2	21	149	8,9	1384	6,4	29	841	10,6	36	31	1116	8
	3	23,5	182	10,9	1734	6,3	33	1089	10	40	35	1400	7,8
	4	26	211	12,6	2123	5,9	36	1296	9,7	44	39	1716	7,3
	5	28	236	14,2	2461	5,8	39	1521	9,3	48	42	2016	7



### Irrigatore "Condor" setto 1"1/2" femmina

*Irrigator "Condor" 1" 1/2" female sector*

**CODICE** • Code

**70.F.S0112**

Irrigatore di media portata circolare e settore regolabile. E' dotato di ugelli intercambiabili e di rompgetto a penetrazione regolabile, che permettono precipitazione fine uniformemente distribuita. E' adatto per qualsiasi tipo di impianto e si presta per terreni di qualsiasi natura ed estensione.

**Confezioni minime 10 pz.** • Minimum quantity orders 10 pcs.



### Irrigatore "Condor" circolare 1" 1/2" femmina

*Irrigator "Condor" 1" 1/2" female circular*

**CODICE** • Code

**70.F.C0112**

Middle flow rate circular irrigator or with adjustable sector. It is provided with interchangeable nozzles and adjustable penetration jet-breaker which allow a fine and uniformly distributed precipitation. It is suitable for any type of sistem and fit for grounds of any sort and extent.

**Confezioni minime 10 pz.** • Minimum quantity orders 10 pcs.

U Diametro ugello Nozzle Diameter	P Pressione Pressure	G Gittata Jet length	Q Portata Capacity		● Dati relativi ad un irrigatore Values for a single sprinkler		■ Disposizione in quadrato Square pattern			▲ Disposizione in triangolo Triangular pattern			
					S Superficie irrigata Irrigated area	I Intensità oraria Rainfall per hour	D Distanza irrigatori sull'ala piovana Distance of the sprinklers on the pipeline	S Superficie irrigata Irrigated area	I Intensità oraria Rainfall per hour	D Distanza irrigatori sull'ala piovana Distance of the sprinklers on the pipeline	D <sub>1</sub> Distanza tra 2 ali piovane contigue Distance between 2 contiguous pipelines	S Superficie irrigata Irrigated area	I Intensità oraria Rainfall per hour
mm	atm	m	l/m	m <sup>3</sup> /h	m <sup>2</sup>	mm/h	m	m <sup>2</sup>	mm/h	m	m	m <sup>2</sup>	mm/h
7,5	1,5	15,5	49	2,9	754	3,8	22	484	6	26	23	598	4,8
	2	17	57	3,4	908	3,7	24	576	5,9	29	25	725	4,7
	3	19	69	4,1	1134	3,6	26	676	6	32	28	896	4,6
	4	20,5	80	4,8	1319	3,6	29	841	5,7	35	30	1050	4,5
8	1,5	16,5	62	3,7	855	4,3	23	529	7	28	24	672	5,5
	2	17,5	71	4,2	962	4,3	24	576	7,3	30	26	780	5,4
	3	19,5	87	5,2	1194	4,3	27	729	7,1	33	29	957	5,4
	4	21	100	6	1384	4,3	29	841	7,1	36	31	1116	5,3
10	1,5	17	76	4,5	908	4,9	24	576	7,8	29	25	725	6,2
	2	18	88	5,3	1017	5,2	25	625	8,4	31	27	837	6,3
	3	20,5	107	6,4	1319	4,8	29	841	7,6	35	30	1050	6,1
	4	22	124	7,4	1520	4,8	31	961	7,7	38	33	1254	5,9
12	1,5	17	110	6,6	908	7,2	24	576	11,4	29	25	725	9,1
	2	19	127	7,6	1134	6,7	26	676	11,2	32	28	896	8,5
	3	21	155	9,3	1384	6,7	29	841	11	36	31	1116	8,3
	4	23,5	179	10,7	1734	6,2	33	1089	9,8	40	35	1400	7,6





**Irrigatore "Jenny"  
circolare bigetto 1" femmina**  
*Irrigator "Jenny" 1" female circular - 2 jet*

**CODICE** - Code

**70.F.CB001**

Irrigatore due getti di piccola portata circolare ed settore regolabile, per medie e basse pressioni. I due getti, con diversa inclinazione, sono dotati di ugelli intercambiabili e di rompigetti a penetrazione regolabile, che permettono precipitazioni fini e localizzate a piacimento. E' adatto per l'irrigazione di colture miste, ortaggi, fiori, frutteti, campi da gioco.

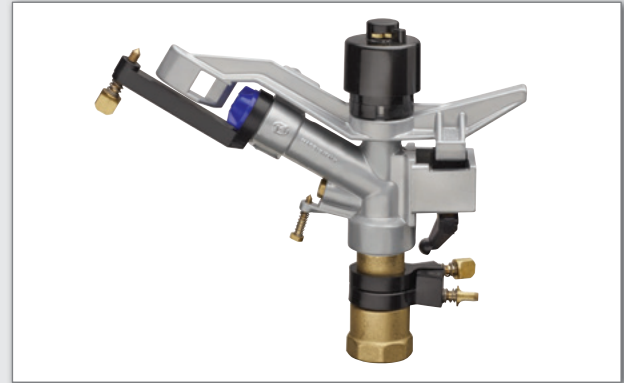

**Irrigatore "Jenny"  
settore bigetto 1" femmina**  
*Irrigator "Jenny" 1" female sector - 2 jet*

**CODICE** - Code

**70.F.SB001**

Small flow rate double-jet circular irrigator or with adjustable sector, for middle and low pressures. The two jets, slanting in a different way, are provided with interchangeable nozzles and adjustable-penetration jet-breakers which allow fine and uniformly distributed precipitations. It is suitable for irrigating mixed cultivations, vegetables, flowers, orchards, sports fields.

**Confezioni minime 10 pz.** • Minimum quantity orders 10 pcs.

**Confezioni minime 10 pz.** • Minimum quantity orders 10 pcs.

U Diametro ugello Nozzle Diameter	P Pressione Pressure	G Gittata Jet length	Q Portata Capacity		● Dati relativi ad un irrigatore Values for a single sprinkler		■ Disposizione in quadrato Square pattern			▲ Disposizione in triangolo Triangular pattern			
					S Superficie irrigata Irrigated area	I Intensità oraria Rainfall per hour	D Distanza irrigatori sull'ala piovana Distance of the sprinklers on the pipeline	S Superficie irrigata Irrigated area	I Intensità oraria Rainfall per hour	D Distanza irrigatori sull'ala piovana Distance of the sprinklers on the pipeline	D <sub>1</sub> Distanza tra 2 ali piovane contigue Distance between 2 conti- guous pipelines	S Superficie irrigata Irrigated area	I Intensità oraria Rainfall per hour
mm	atm	m	l/m	m <sup>3</sup> /h	m <sup>2</sup>	mm/h	m	m <sup>2</sup>	mm/h	m	m	m <sup>2</sup>	mm/h
4 — 6,5	1,5	13	46	2,7	530	5	18	324	8,3	22	19	418	6,4
	2	15	54	3,2	706	4,5	21	441	7,3	25	22	550	5,8
	3	17	66	3,9	907	4,2	24	576	6,7	29	25	725	5,4
	4	18	77	4,6	1017	4,5	25	625	7,3	31	27	837	5,4
4 — 8	1,5	14,5	69	4,1	660	6,2	20	400	10,2	25	21	525	7,8
	2	16,5	79	4,7	854	5,5	23	529	8,9	28	24	672	7
	3	18	96	5,7	1017	5,6	25	625	9,2	31	27	837	6,8
	4	19	112	6,7	1134	5,9	26	676	9,9	32	28	986	6,8
4 — 10	1,5	16	96	5,7	804	7	22	484	11,7	27	24	648	8,8
	2	17	110	6,6	907	7,2	24	576	11,4	29	25	725	9,1
	3	19,5	134	8	1193	6,7	27	729	10,9	33	29	957	8,3
	4	21	156	9,3	1385	6,7	29	841	11	36	31	1116	8,3



**Irrigatore "Piper" circolare 1" femmina**

*Irrigator "Piper" 1" female circular*

**CODICE** - Code

**70.F.C0001**

Irrigatore di piccola portata circolare ed settore regolabile, per medie e basse pressioni. E' dotato di ugelli intercambiabili e di un rompighetto a penetrazione regolabile, che assicura una precipitazione fine e uniformemente distribuita. E' adatto per l'irrigazione di colture miste, ortaggi, fiori, frutteti, campi da gioco e per la protezione antibrina.



**Irrigatore "Piper" settore 1" femmina**

*Irrigator "Piper" 1" female sector*

**70.F.S0001**

Small flow rate circular irrigator or with adjustable sector, for middle and low pressures. It is provided with interchangeable nozzles and an adjustable-penetration jet-breaker which allow a fine and uniformly distributed precipitation. It is suitable for irrigating mixed cultivations, vegetables, flowers, orchards, sports fields and anti-frost protection.

U	P	G	Q		Dati relativi ad un irrigatore Values for a single sprinkler		Disposizione in quadrato Square pattern			Disposizione in triangolo Triangular pattern			
					Superficie irrigata Irrigated area	Intensità oraria Rainfall per hour	Distanza irrigatori sulla piovana Distance of the sprinklers on the pipeline	Superficie irrigata Irrigated area	Intensità oraria Rainfall per hour	Distanza irrigatori sulla piovana Distance of the sprinklers on the pipeline	Distanza tra 2 ali contigue Distance between 2 contiguous pipelines	Superficie irrigata Irrigated area	Intensità oraria Rainfall per hour
mm	atm	m	l/m	m <sup>3</sup> /h	m <sup>2</sup>	mm/h	m	m <sup>2</sup>	mm/h	m	m	m <sup>2</sup>	mm/h
7,5	1,5	15,5	49	2,9	754	3,8	22	484	6	26	23	598	4,8
	2	17	57	3,4	908	3,7	24	576	5,9	29	25	725	4,7
	3	19	69	4,1	1134	3,6	26	676	6	32	28	896	4,6
	4	20,5	80	4,8	1319	3,6	29	841	5,7	35	30	1050	4,5
8	1,5	16,5	62	3,7	855	4,3	23	529	7	28	24	672	5,5
	2	17,5	71	4,2	962	4,3	24	576	7,3	30	26	780	5,4
	3	19,5	87	5,2	1194	4,3	27	729	7,1	33	29	957	5,4
	4	21	100	6	1384	4,3	29	841	7,1	36	31	1116	5,3
10	1,5	17	76	4,5	908	4,9	24	576	7,8	29	25	725	6,2
	2	18	88	5,3	1017	5,2	25	625	8,4	31	27	837	6,3
	3	20,5	107	6,4	1319	4,8	29	841	7,6	35	30	1050	6,1
	4	22	124	7,4	1520	4,8	31	961	7,7	38	33	1254	5,9
12	1,5	17	110	6,6	908	7,2	24	576	11,4	29	25	725	9,1
	2	19	127	7,6	1134	6,7	26	676	11,2	32	28	896	8,5
	3	21	155	9,3	1384	6,7	29	841	11	36	31	1116	8,3
	4	23,5	179	10,7	1734	6,2	33	1089	9,8	40	35	1400	7,6



**Irrigatore "Star" circolare 3/4"**  
*Irrigator "Star" 3/4" circular*

**Confezioni minime 10 pz.**  
*Minimum quantity orders 10 pcs.*

**CODICE** - Code

**70.F.C0034** Maschio • Male

**70.F.C0F34** Femmina • Female



**Irrigatore "Star" settore 3/4"**  
*Irrigator "Star" 3/4" sector*

**Confezioni minime 10 pz.**  
*Minimum quantity orders 10 pcs.*

**CODICE** - Code

**70.F.S0034** Maschio • Male

**70.F.C0F34** Femmina • Female



**Irrigatore "Colibrì" circolare 1/2" 1 getto**  
*1 jet irrigator "Colibrì" 1/2" circular*

**Confezioni minime 10 pz.**  
*Minimum quantity orders 10 pcs.*

**CODICE** - Code

**70.F.C0012** Maschio • Male

**70.F.C0F12** Femmina • Female

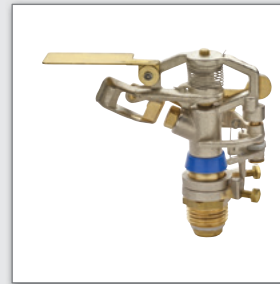

**Irrigatore "Colibrì" settore 1/2" 1 getto**  
*1 jet irrigator "Colibrì" 1/2" sector*

**Confezioni minime 10 pz.**  
*Minimum quantity orders 10 pcs.*

**CODICE** - Code

**70.F.S0012** Maschio • Male

**70.F.S0F12** Femmina • Female

Pressione • Pressure	ATM 2
Gittata • Range	MT 12
Litri minuto • Liter minuts	L/m 13



**Irrigatore fisso 360°  
attacco 1/2" femmina**

*Fixed 360° irrigator 1/2" female*

**CODICE** • Code

**70.F.00012**

**Confezioni minime 10 pz.**  
*Minimum quantity orders 10 pcs.*



**Irrigatore fisso 360° attacco 1/2" femmina  
completo di puntale**

*Fixed 360° irrigator 1/2" female with aluminium fitting*

**CODICE** • Code

**70.F.34012**

**Confezioni minime 10 pz.**  
*Minimum quantity orders 10 pcs.*



**Puntale in alluminio per irrigatori da 1/2"  
maschio doppio attacco completo di raccordi ø 13**

*Aluminium fitting for irrigators - 1/2" male, double connection ø 13*

**Confezioni minime 10 pz.**  
*Minimum quantity orders 10 pcs.*

**CODICE** • Code

**34.F.13013**

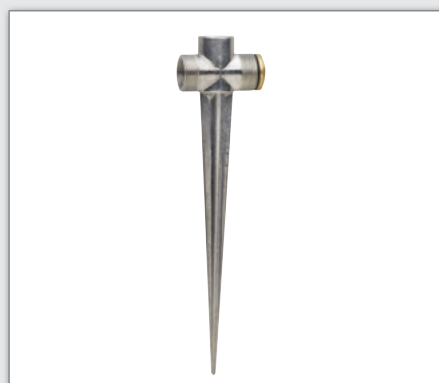

**Puntale in alluminio per irrigatori da 1/2" maschio**

*Aluminium fitting for irrigators - 1/2" male*

**Confezioni minime 10 pz.**  
*Minimum quantity orders 10 pcs.*

**CODICE** • Code

**34.F.00012**



### Puntale in alluminio per irrigatori da 1/2" maschio con raccordi ø 13

Aluminium fitting for irrigators - 1/2" male, single connection ø 13

**Confezioni minime 10 pz.**  
Minimum quantity orders 10 pcs.

**CODICE** • Code

**34.F.13012**



### Portagomma 2 pz con dado

Heavy combined 2 pc hose with hexagonal nut

**Confezioni minime 10 pz.**  
Minimum quantity orders 10 pcs.

**CODICE** • Code

**28.F.10413**

**28.T.12013** 1/2" m ø 13



### Tappo esagonale 23x1/2"

Hexagonal plug 23x1/2"

**Confezioni minime 10 pz.**  
Minimum quantity orders 10 pcs.

**CODICE** • Code

**49.T.23012**

**49.F.00012** 1/2" m



### Colonnina 3 piedi

Tripud stud

**CODICE** • Code

**MISURA** • Size

**40.K.00001** 1" M

**40.K.00012** 1/2" M

**40.K.00034** 3/4" M

**40.K.00114** 1" 1/4" M

**40.K.00112** 1" 1/2" M

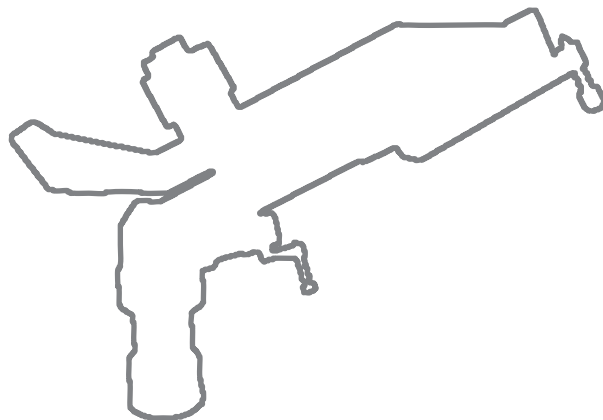

**IRRIGATORI 1.1/2" e 2"**  
*Sprinklers 1.1/2" and 2"*

*Disponibili da febbraio • New release on february*

**CODICE** • Code

<b>70.F.112SB</b>	IRRIGATORE ISEO 2 GETTI 1.1/2" SETTORE • <i>Double jet irrigator Iseo 1.1/2" sector</i>
<b>70.F.112CB</b>	IRRIGATORE ISEO 2 GETTI 1.1/2" CIRCOLARE • <i>Double jet irrigator Iseo 1.1/2" circular</i>

**CODICE** • Code

<b>70.F.SB002</b>	IRRIGATORI GARDA 2 GETTI 2" SETTORE • <i>Double jet irrigator Garda 2" sector</i>
<b>70.F.CB002</b>	IRRIGATORI GARDA 2 GETTI 2" CIRCOLARE • <i>Double jet irrigator Garda 2" circular</i>



I prezzi s'intendono per merce resa franco stabilimento. La merce viaggia sempre ad esclusivo rischio e pericolo del committente. Il venditore non risponde d'eventuali soste o magazzinaggi e non è tenuto a nessun reclamo presso ferrovie e Società di Navigazione. In caso di ritardato pagamento, il compratore perde eventuale sconto e decorre l'interesse di un 2% superiore al tasso ufficiale della Banca d'Italia, restando in facoltà del venditore di sospendere le ulteriori spedizioni ed annullare le commissioni in corso. Qualunque reclamo per la qualità, quantità, vizi anche non apparenti, termini di consegna ecc. relativi alla merce, deve esser fatto negli otto giorni dall'arrivo della stessa alla stazione fissata nel contratto e il reclamo anche se proposto avanti la competente Autorità Giudiziaria, non sospende l'obbligo del compratore di pagare alle epoche stabilite il prezzo della merce contestata. Qualsiasi reso di merce deve esser preventivamente autorizzato dal venditore. Guasti alle macchine ed ai motori ed ogni sopravvenuta difficoltà nell'approvvigionamento e nelle attività della fabbrica, sono considerati casi di forza maggiore, ed escludono ogni responsabilità del venditore. Qualunque controversia relativa alla presente vendita è di competenza esclusiva del Foro di Brescia, e ciò anche nel caso che il venditore dovesse far uso di tratte o comunque avesse accettato pagamenti presso il compratore.

Caratteristiche dimensioni e materiali non sono impegnativi, pertanto l'azienda si riserva di modificarle in ogni momento senza preavviso per favorire il continuo miglioramento del prodotto.

## IL PRESENTE LISTINO ANNULLA E SOSTITUISCE TUTTI I PRECEDENTI.

- L'imballo è al costo se NEUTRO - GRATUITO se con ns. marchio.
- La spedizione è porto assegnato.
- La merce viaggia a rischio e pericolo del committente.
- Le condizioni di vendita e pagamento concordate con il venditore, sono valide "salvo approvazione" della METAL-PI S.n.c.
- Ci riserviamo aumenti o diminuzioni dei prezzi di listino in relazione al variato costo delle materie prime e spese generali.

### SCONTO \_\_\_\_\_

Discount

### RESA \_\_\_\_\_

Delivery

### PAGAMENTO \_\_\_\_\_

Payment

*Prices are ex-works.*

*Goods are always carried at the consignee's risk, the seller cannot be held responsible for any stop or storage and he is not obliged to answer to any complaint from railways or shipping companies.*

*In case of late payments, the buyer loses any possible discount and to the total amount of the invoice, the seller will add an interest of the landing rate of Banca di Italia plus the 2%, keeping the right to suspend deliveries and to cancel current commissions.*

*Any complaint regarding quality, quantity, defects – obvious or not -, delivery time etc. must be done within eight days from the goods arrival to the destination fixed by the contract. The complaint, even if proposed to the attention of the legal Authority, does not suspend the buyer to be obliged to fulfill the payment of the goods purchased with the agreed times and prices.*

*The seller must beforehand authorize any goods return.*

*Machinery or engine breakdowns and unexpected difficulties in the supplying and in the production, are considered due to force majeure and exclude the seller from any responsibility.*

*Any controversy regarding this sell is of exclusive competence of Foro di Brescia, even if the payment conditions are different from the agreed ones.*

*The pictures are merely indicative. Characteristics, sizes and materials are not mandatory; therefore, the producer reserves the right to change them anytime in order to favor the continuous improvement of the products.*

## **THIS PRICELIST CANCELS AND OVERRIDES ANY PREVIOUS PRICE LIST.**

- *Packing: free only if Metal-Pi marked, if neutral it is an extra cost*
- *Delivery is ex-works*
- *Goods are carried at the consignee's risk*
- *Agreed terms of sale and payment are effective only if Metal-Pi confirms them.*
- *The seller reserves the right of raising or lowering the prices according to the raw material and general costs price fluctuation.*









**METAL-PI s.n.c. di Pasotti Ernesto & Maurizio**  
25065 Lumezzane S.S. (Bs) Italy  
Via Faidana, 50  
Phone +39 030 826018

[www.metalpi.it](http://www.metalpi.it) - [info@metalpi.it](mailto:info@metalpi.it)